

BIONICLE

WWW.BIONICLE.COM



NOCTURN

8935



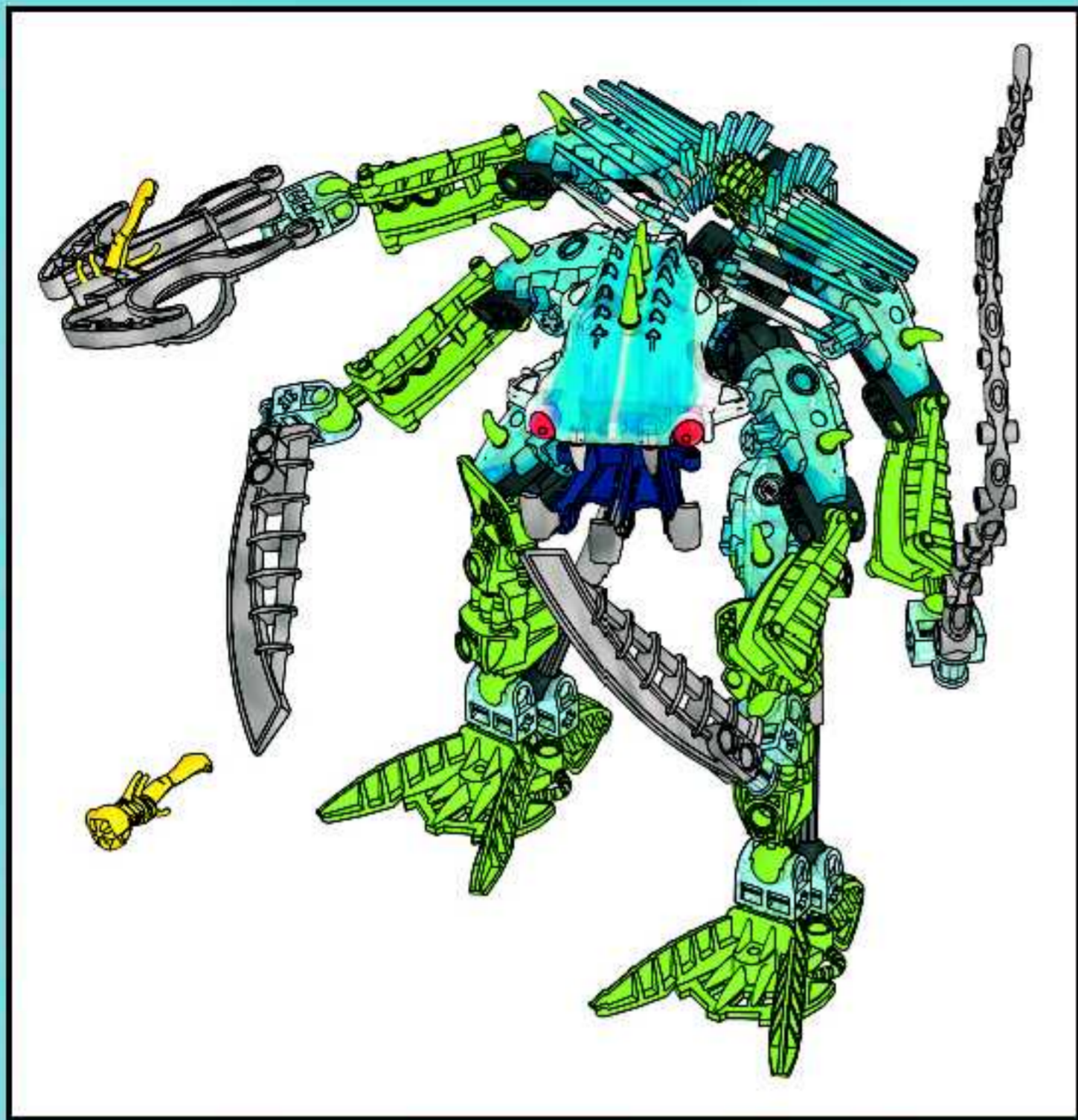

1

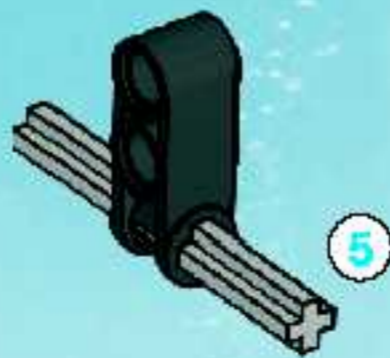



2

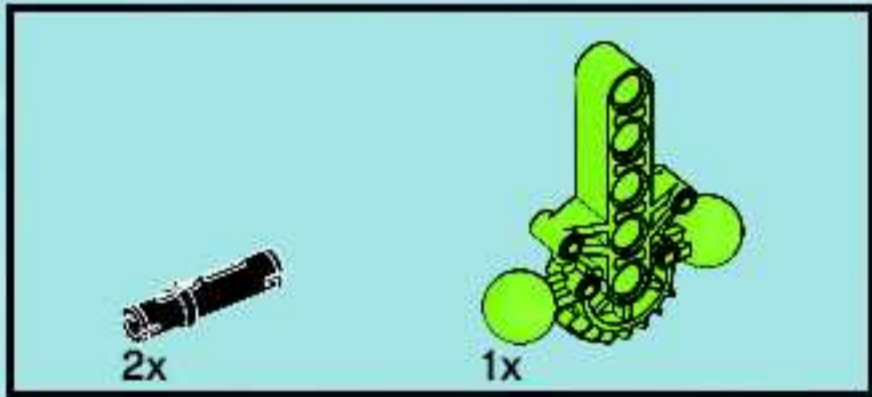
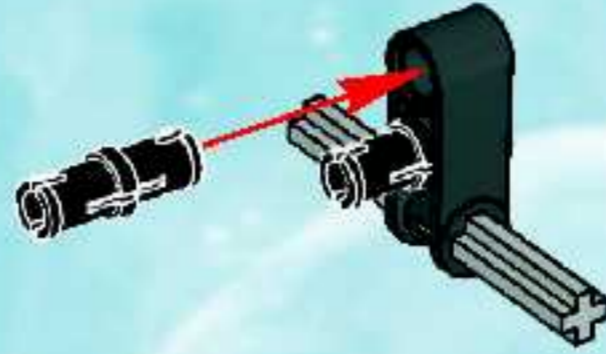

3

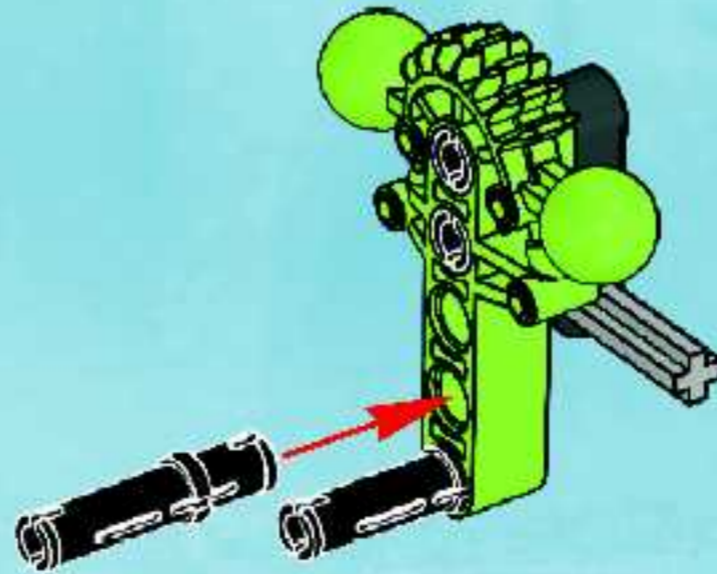

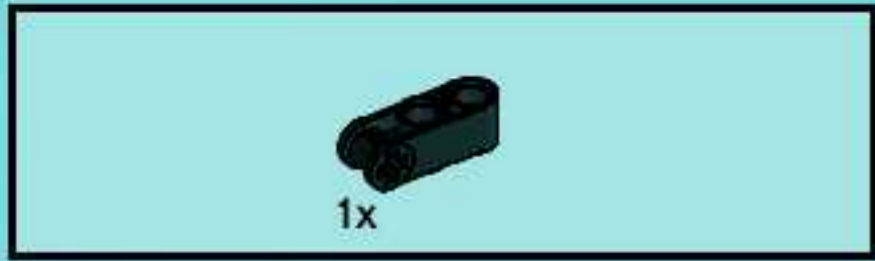

4

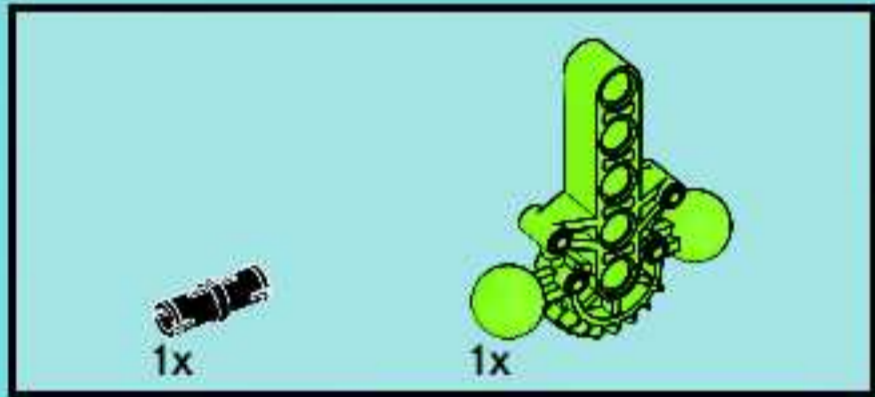
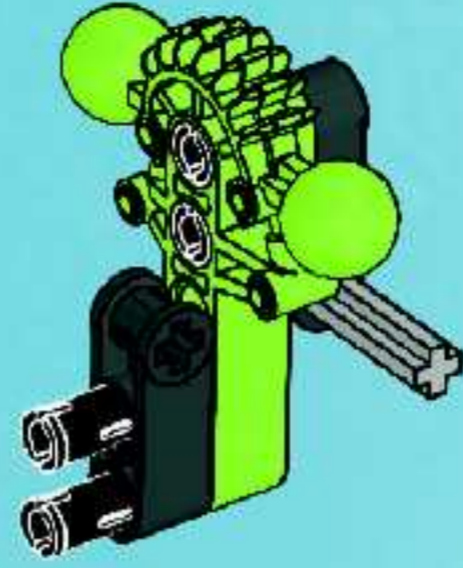

5

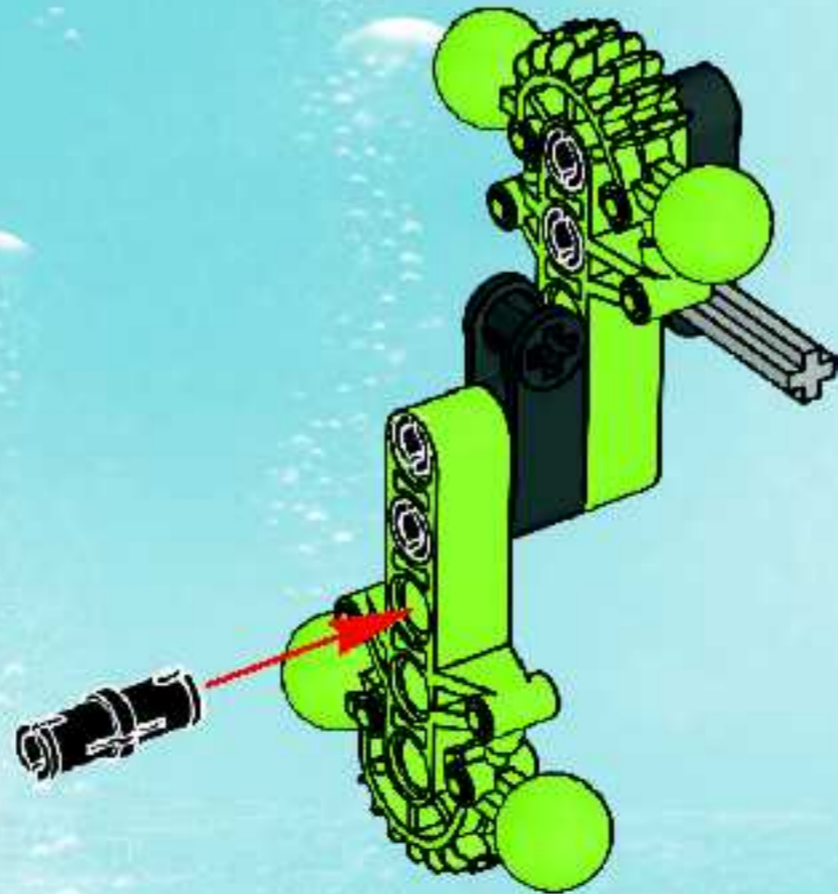

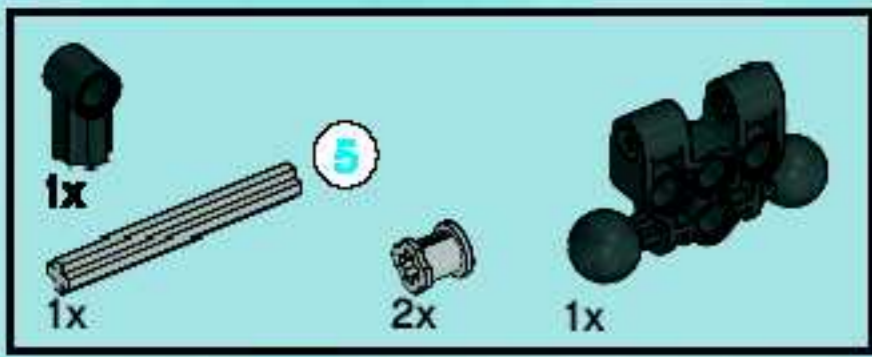

6

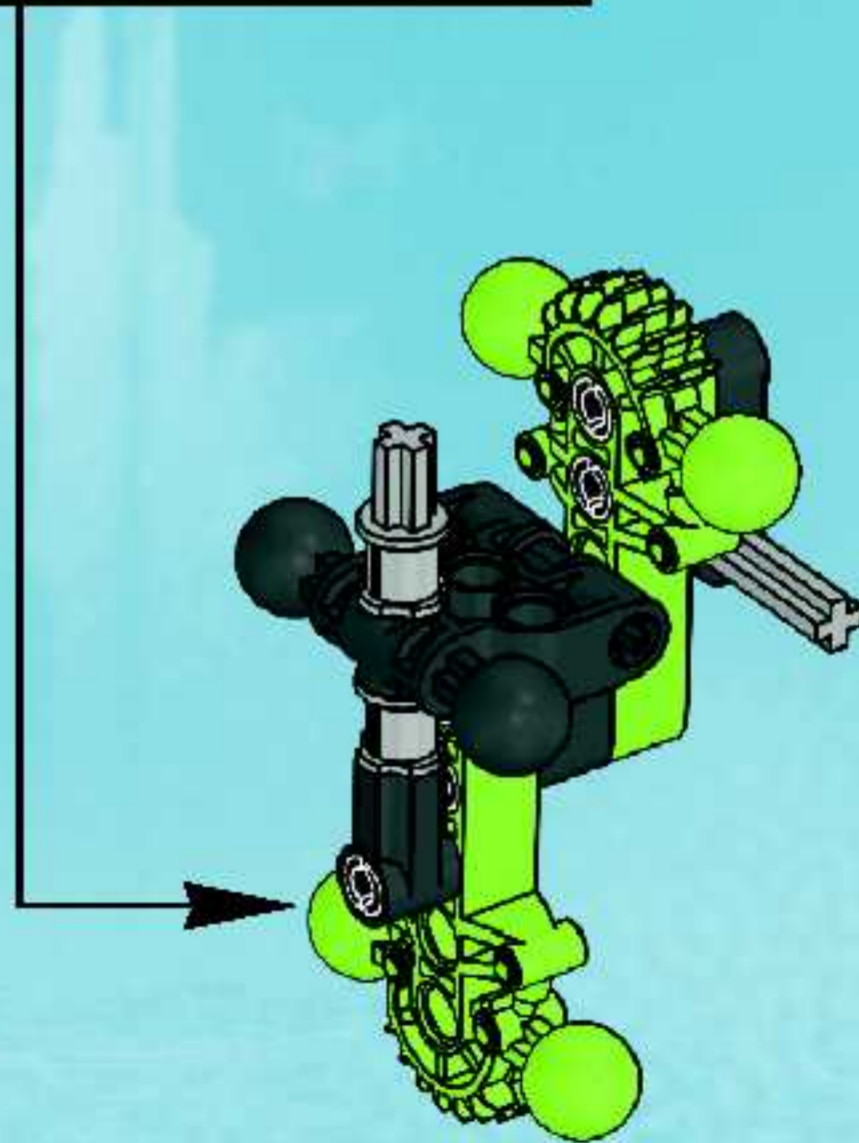
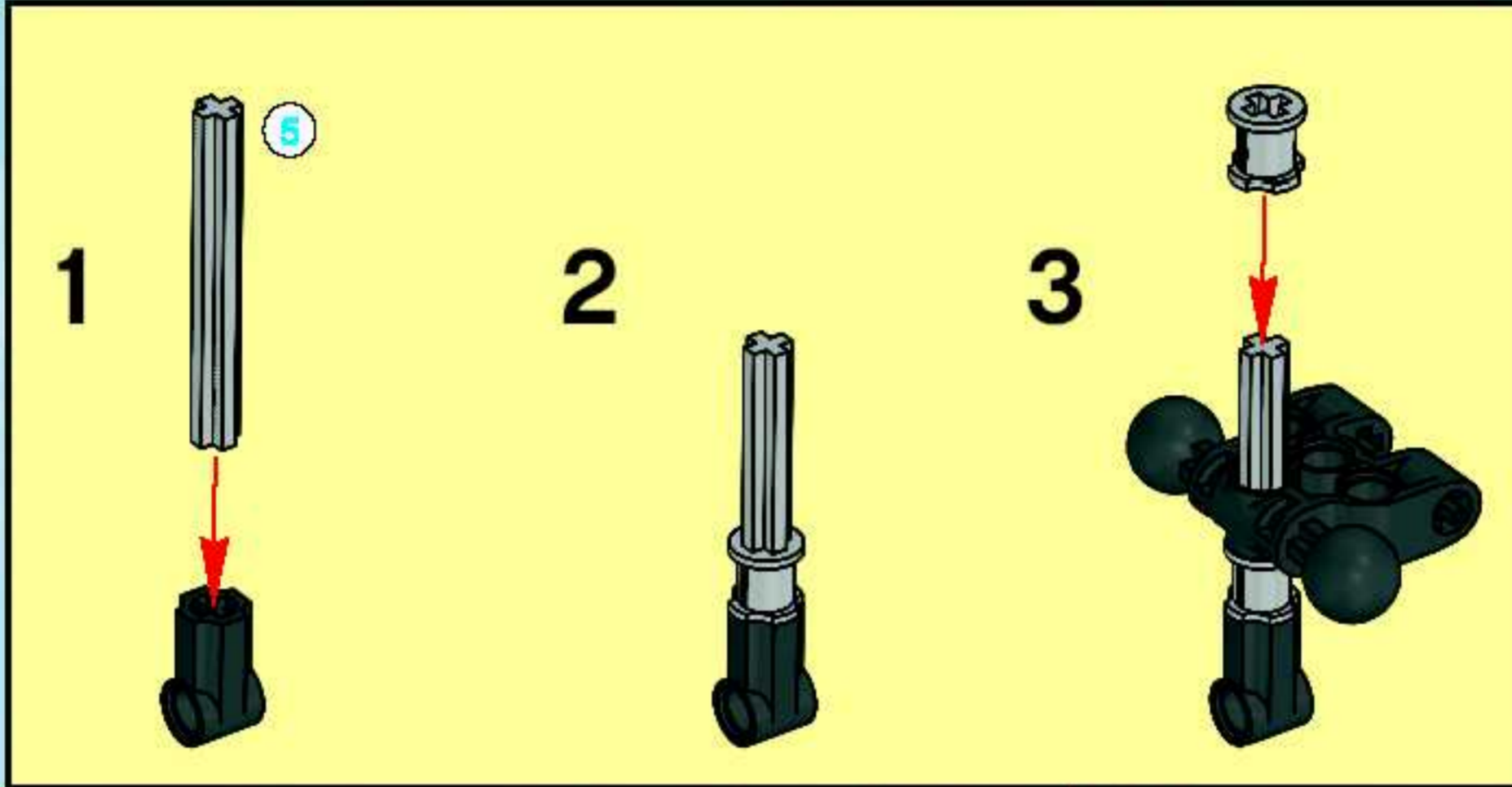

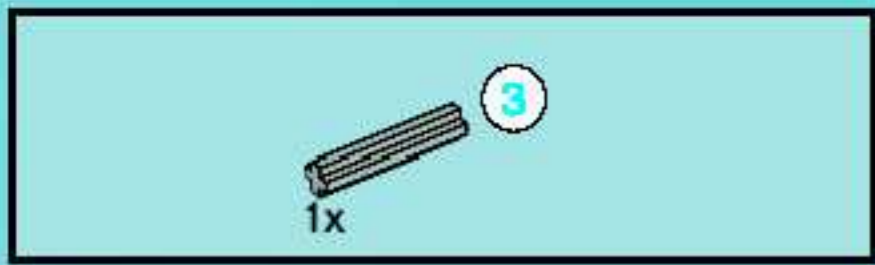

7

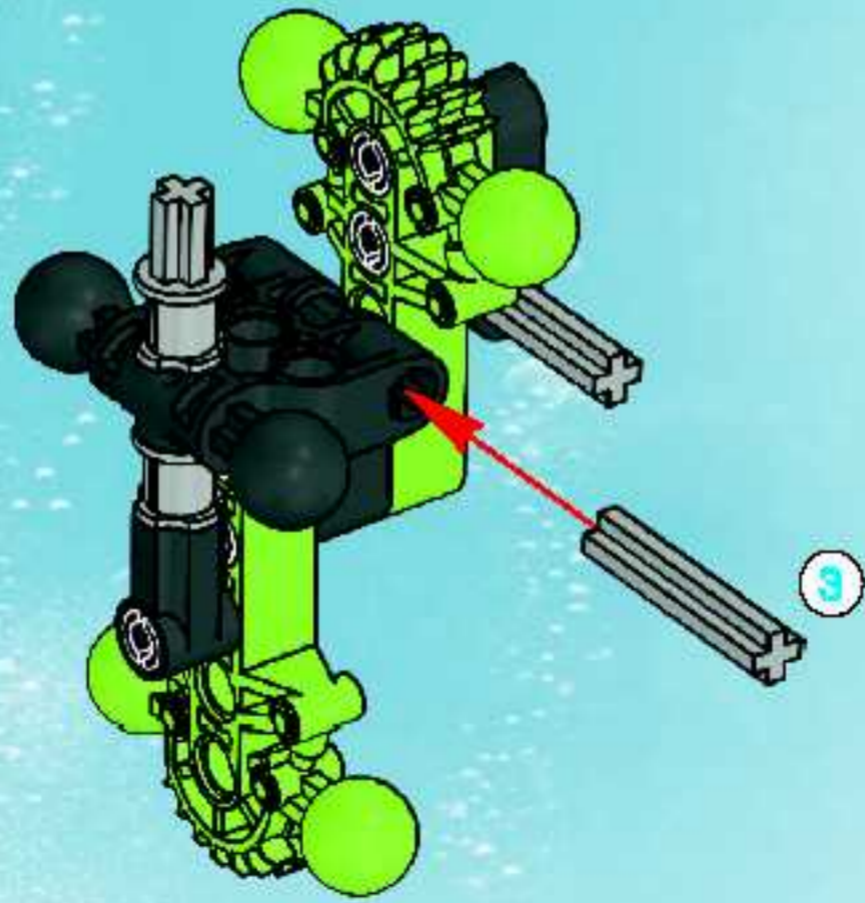



8

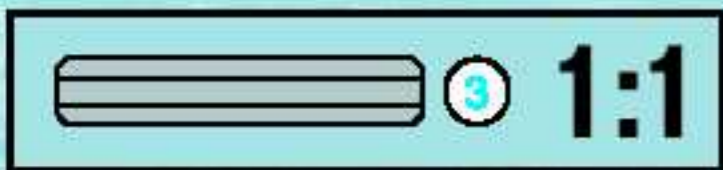
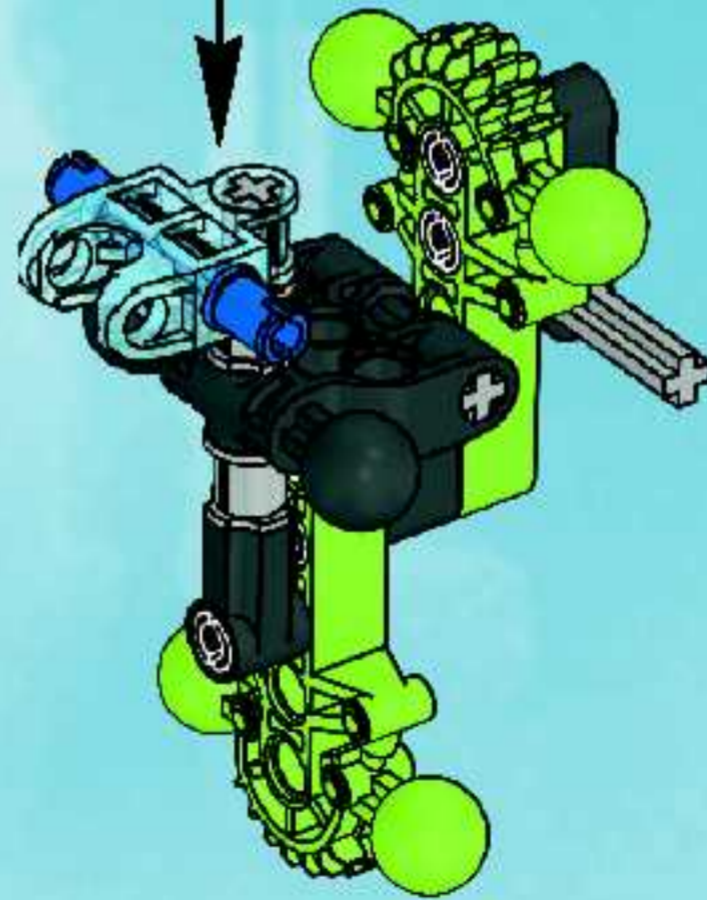
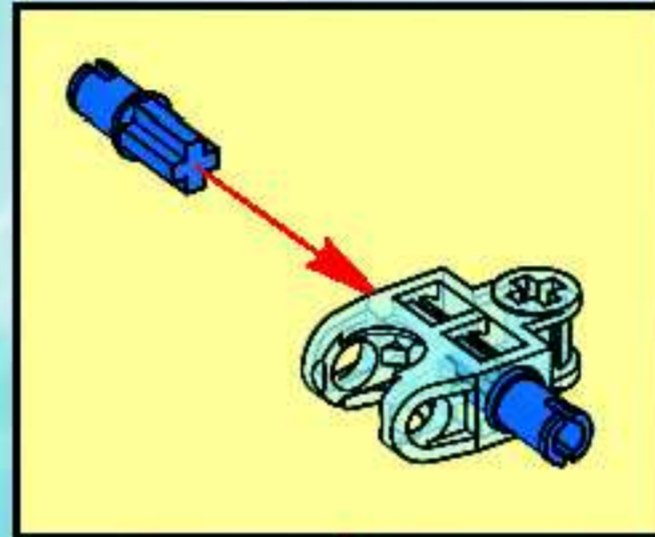

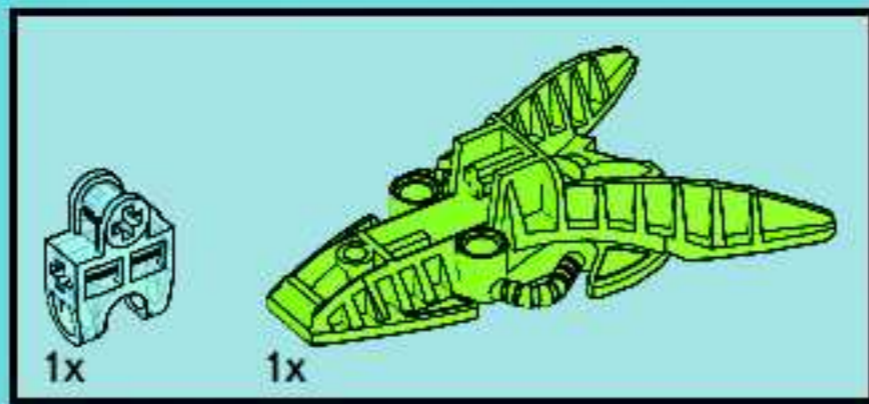
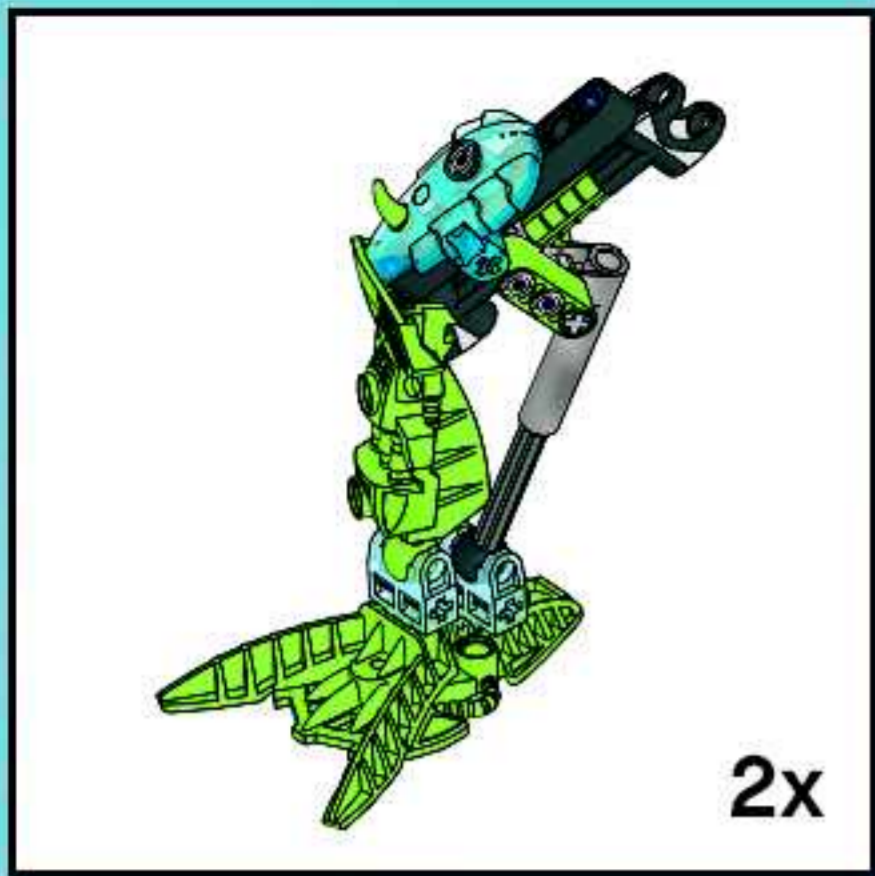

1

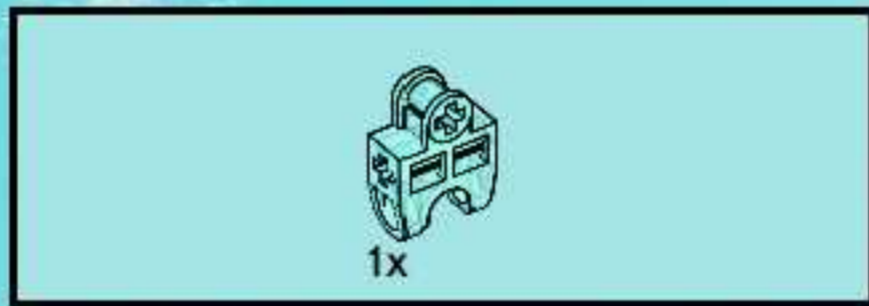
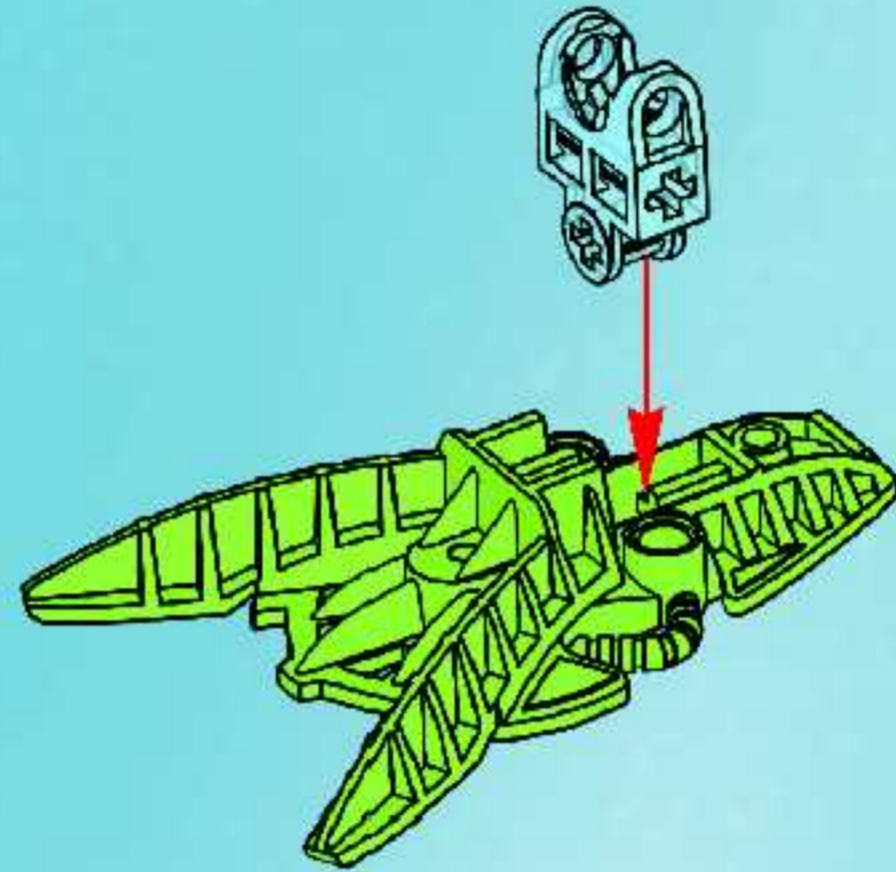

2

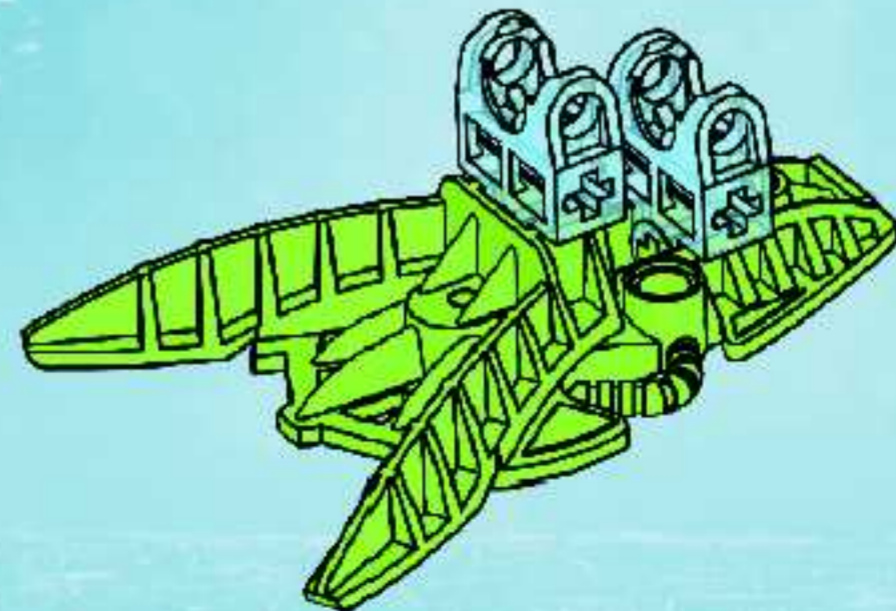

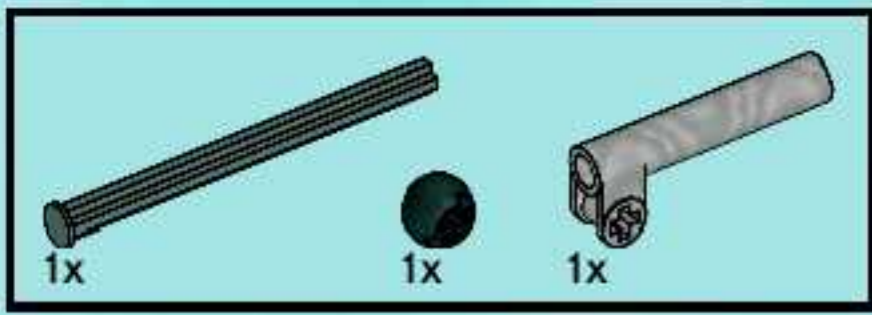

3

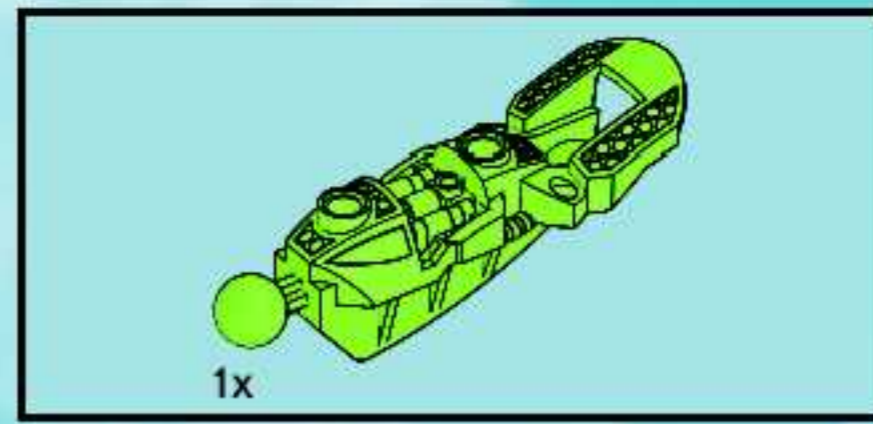
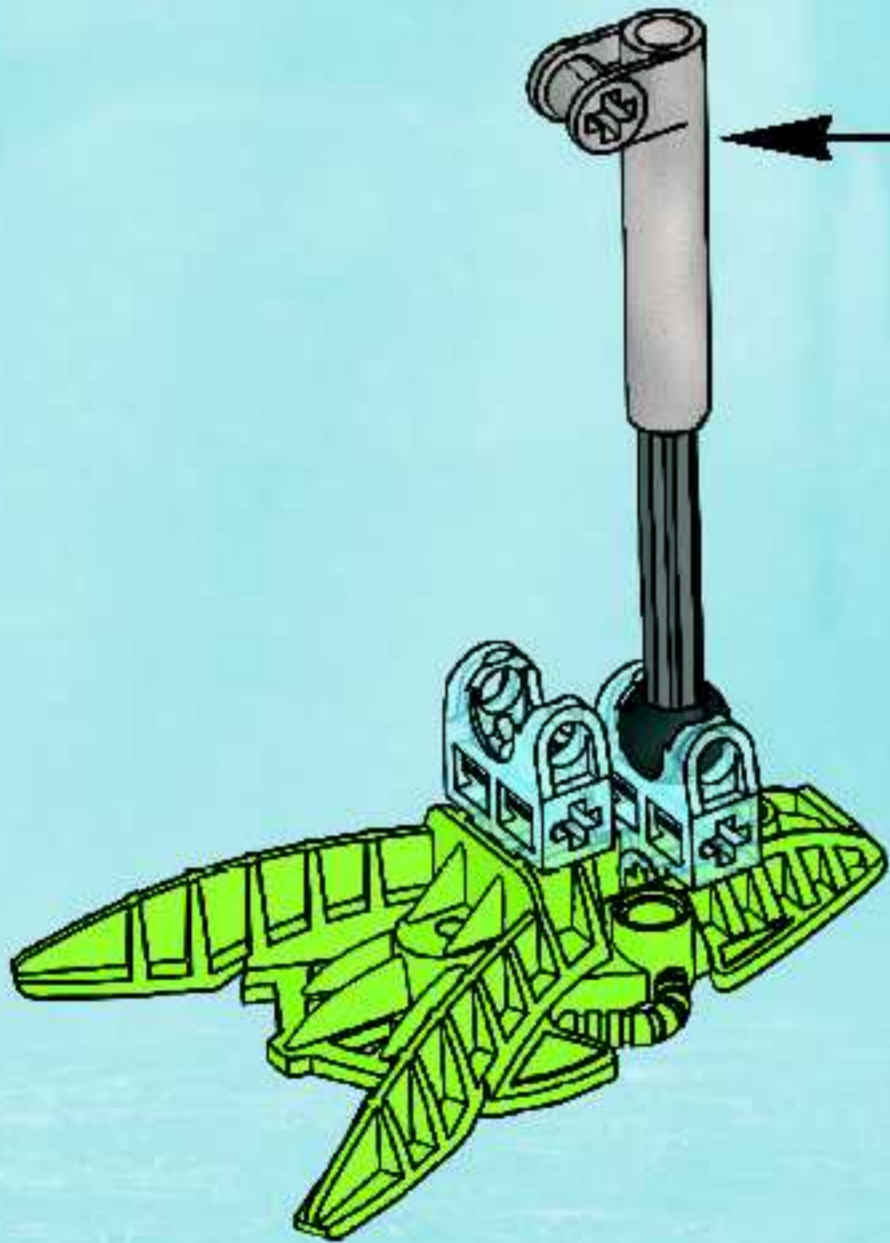
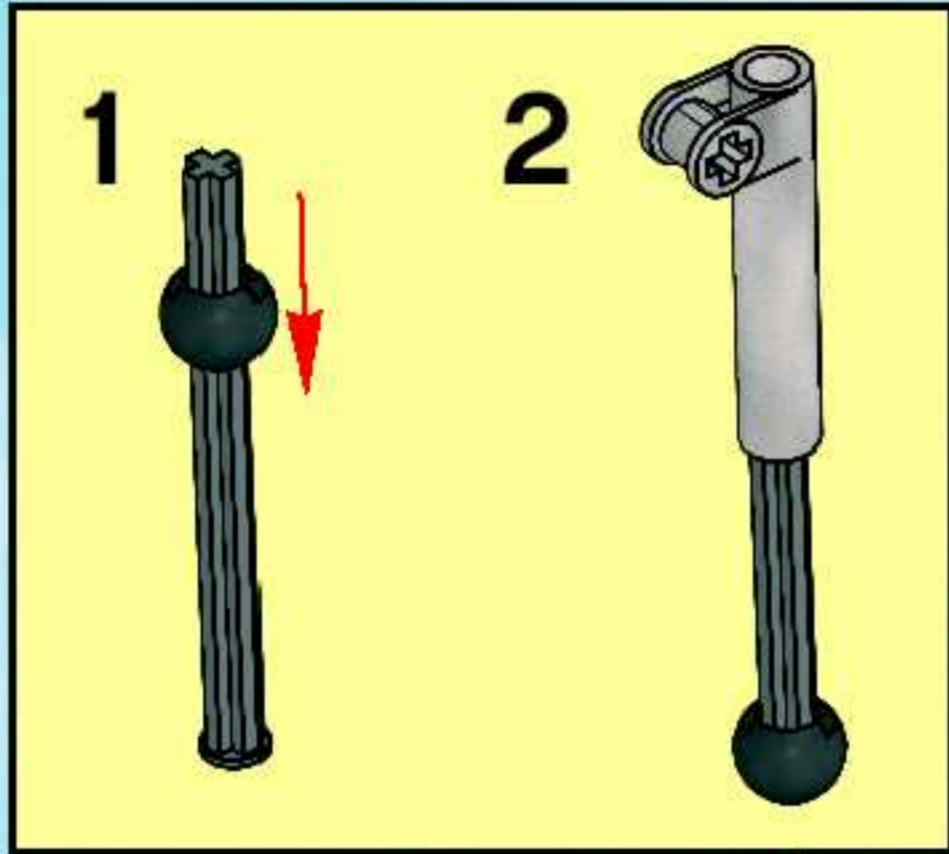

4

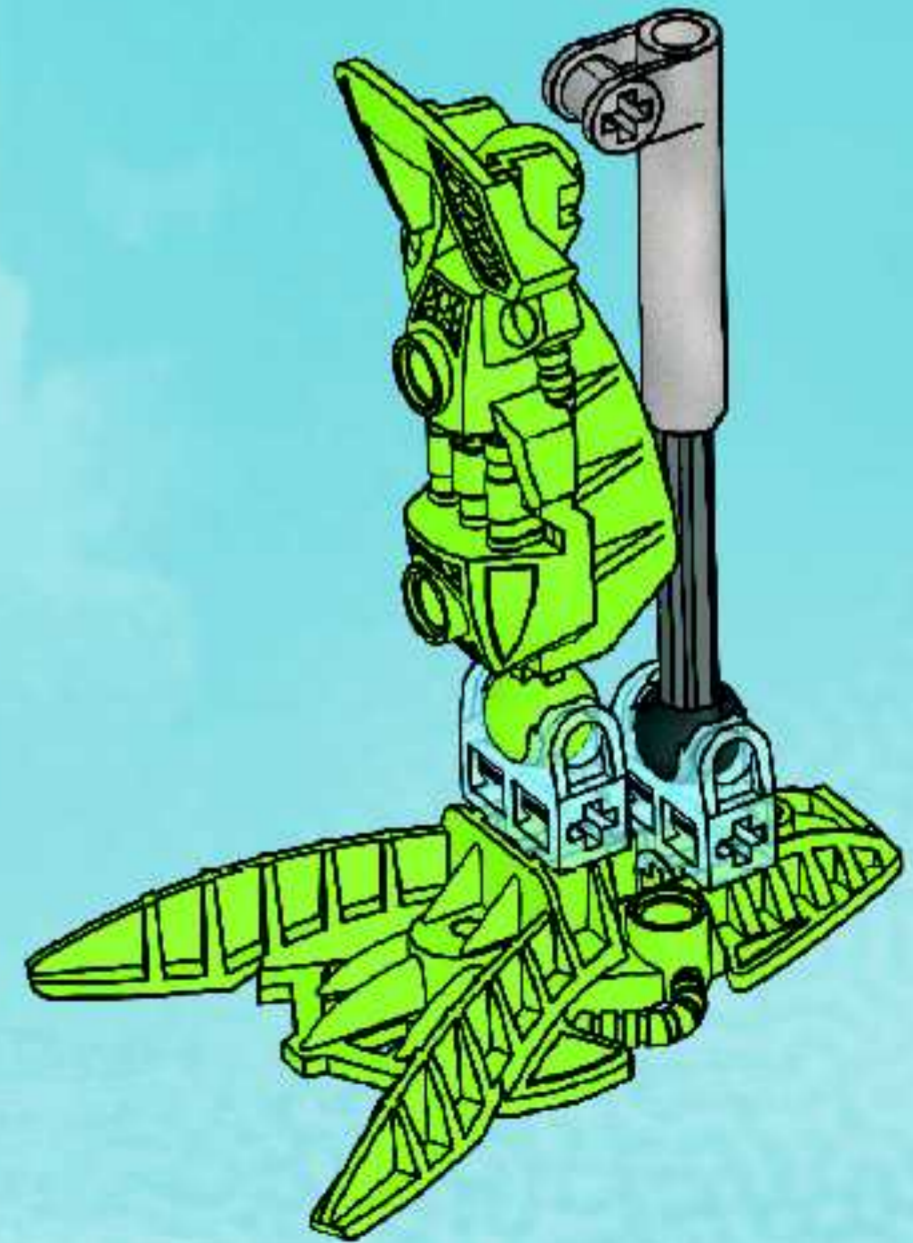

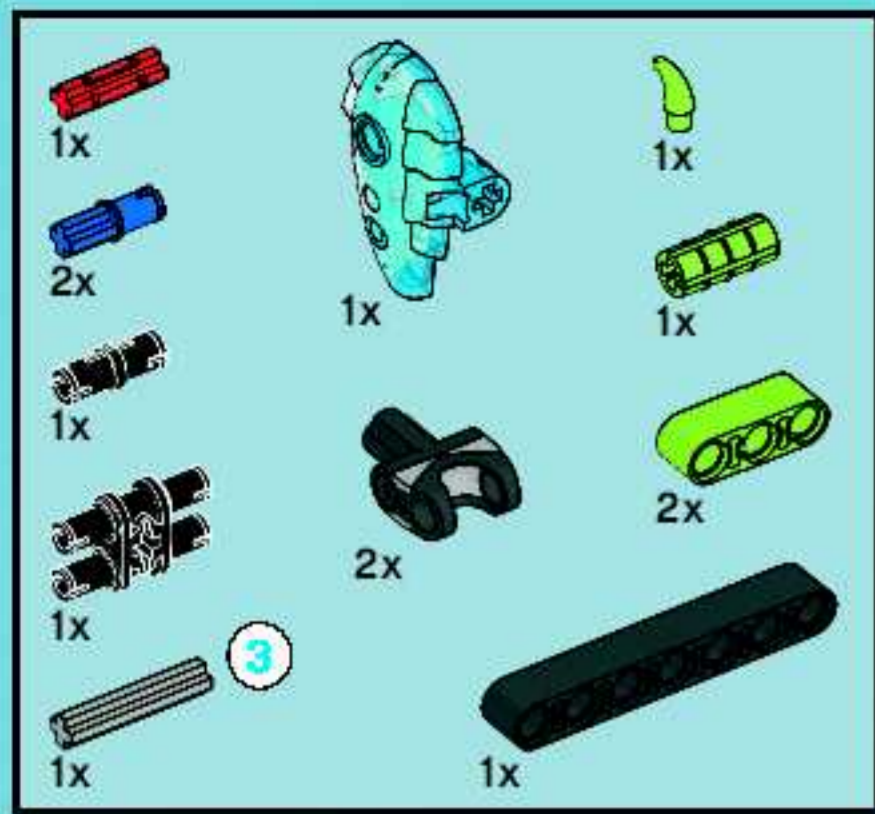

5

1

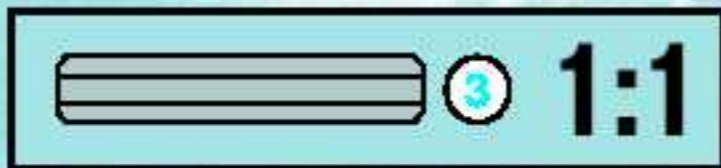

2



3



4



6

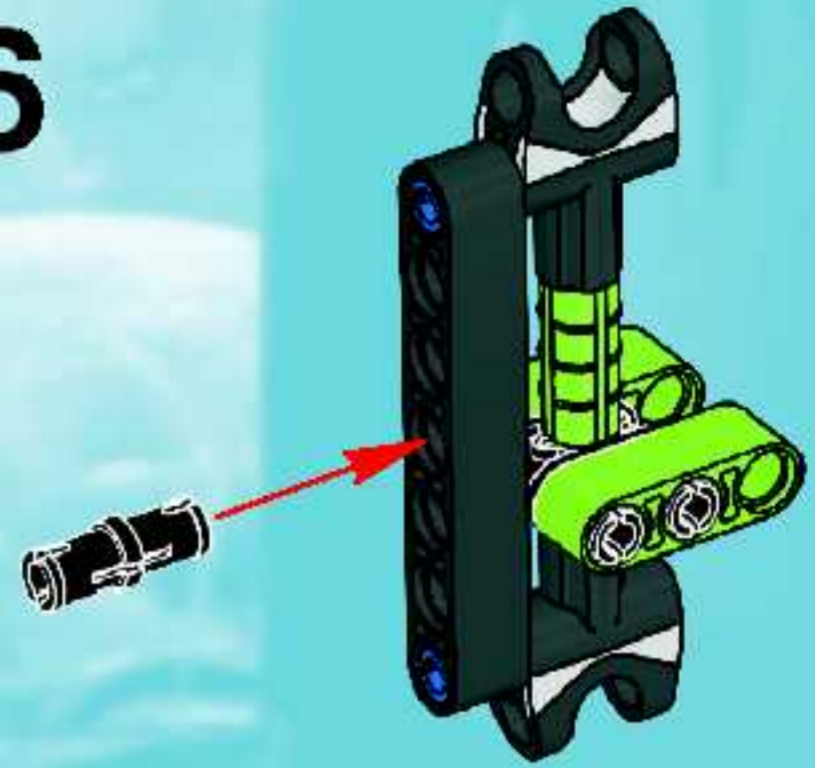

5

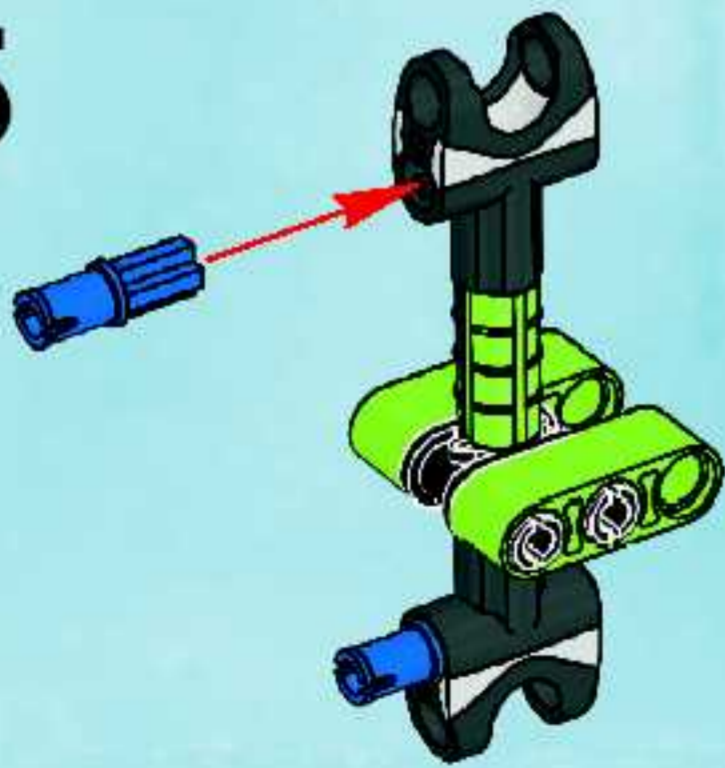

7

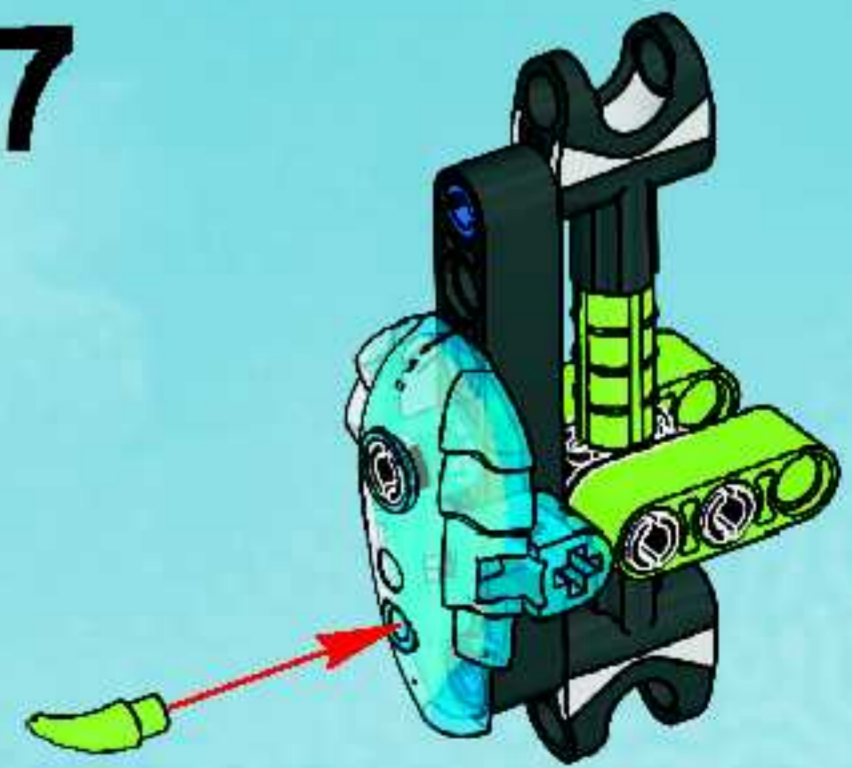

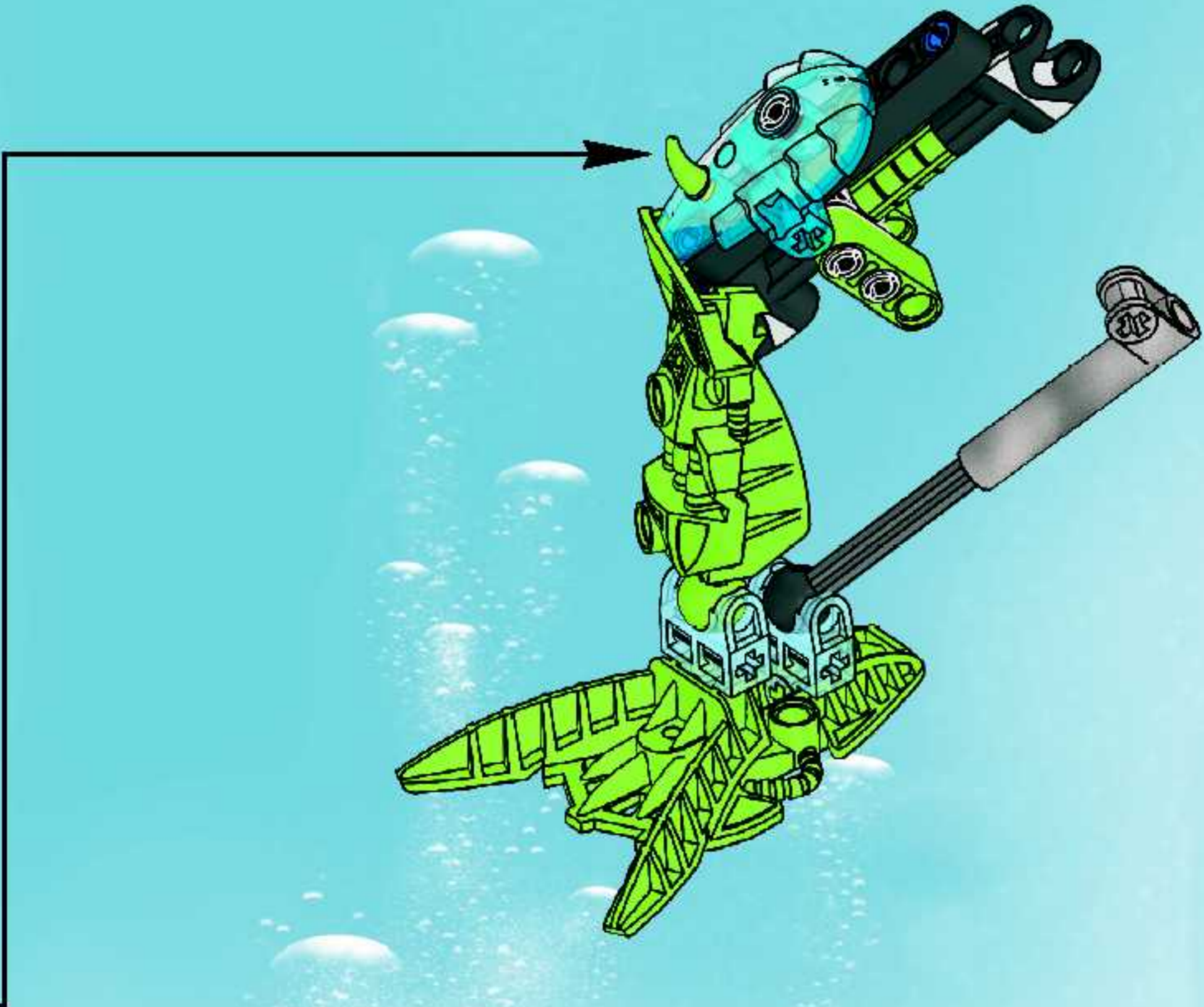

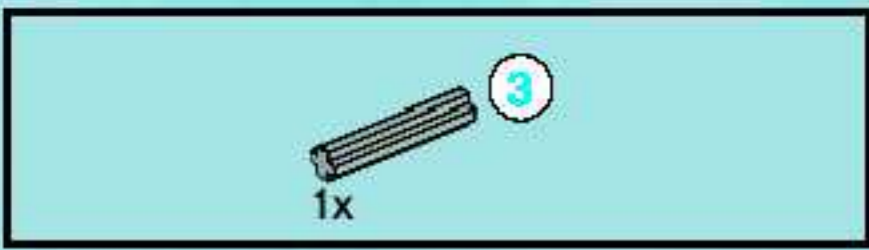

6

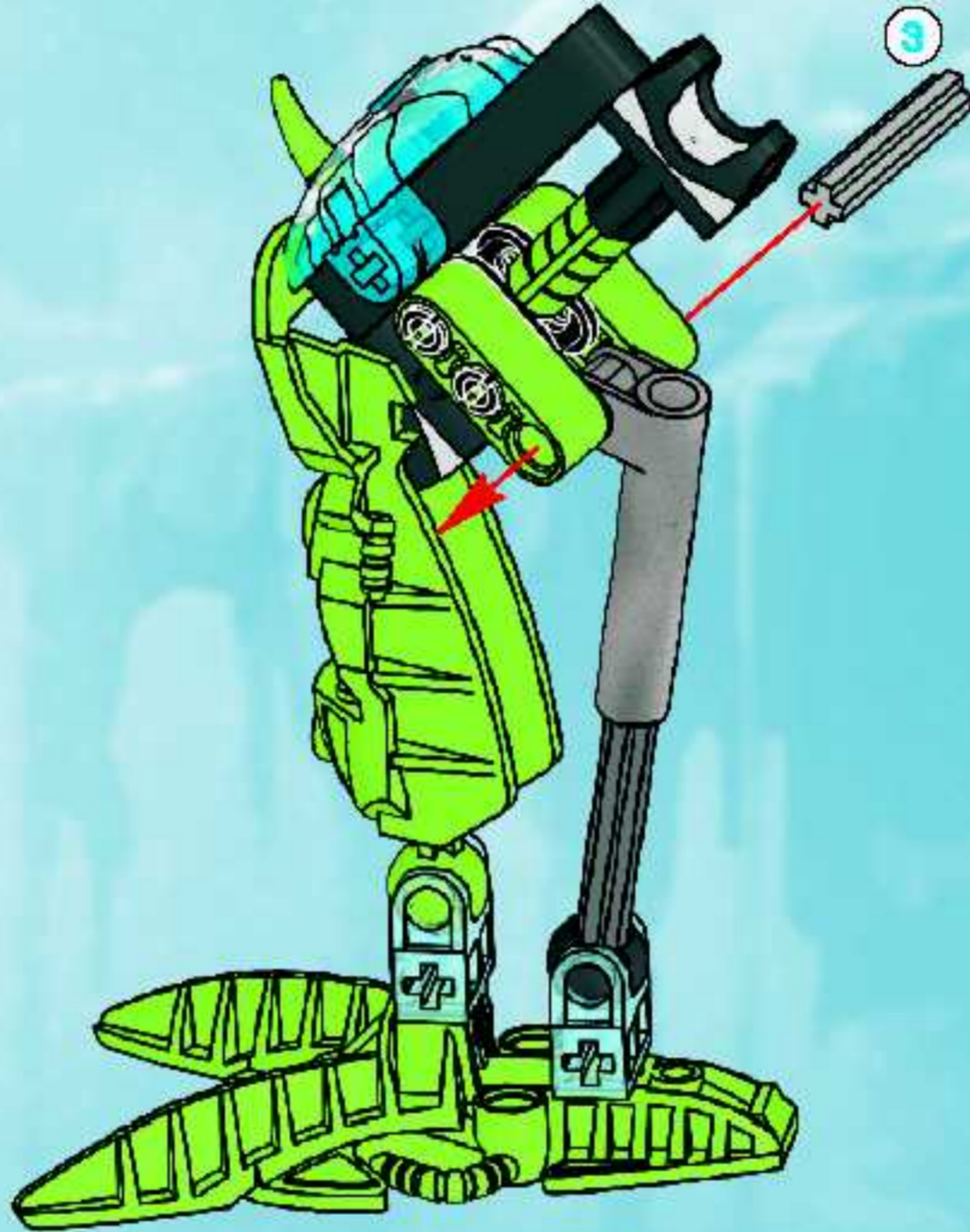

2x

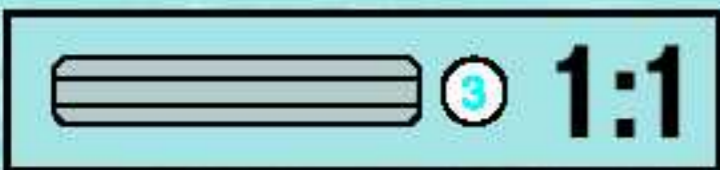

7

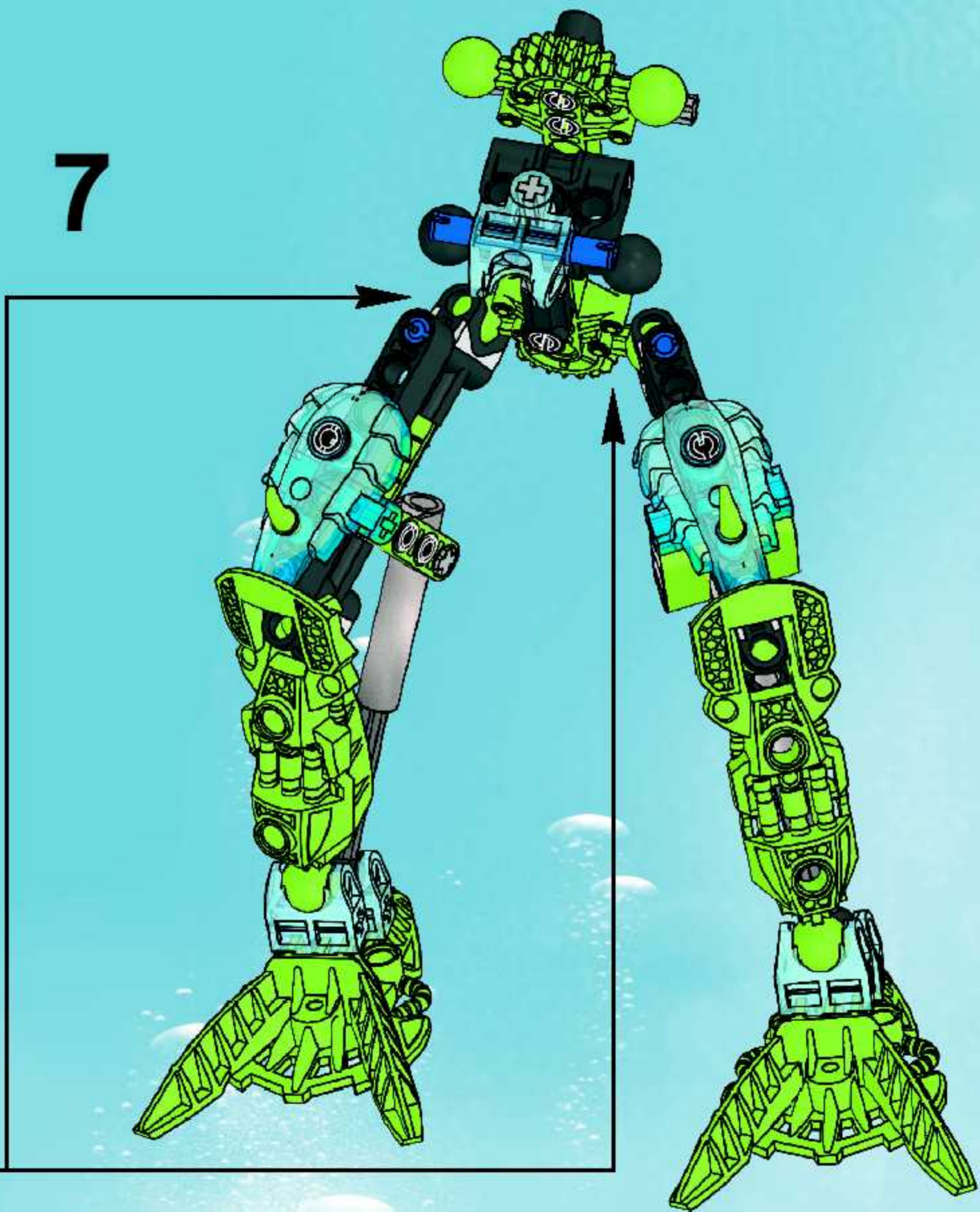

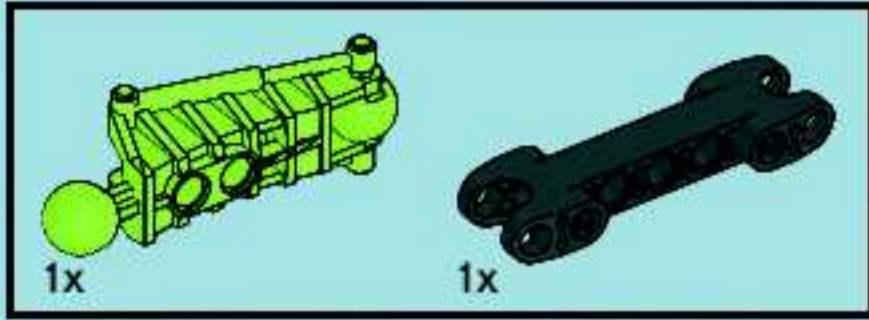
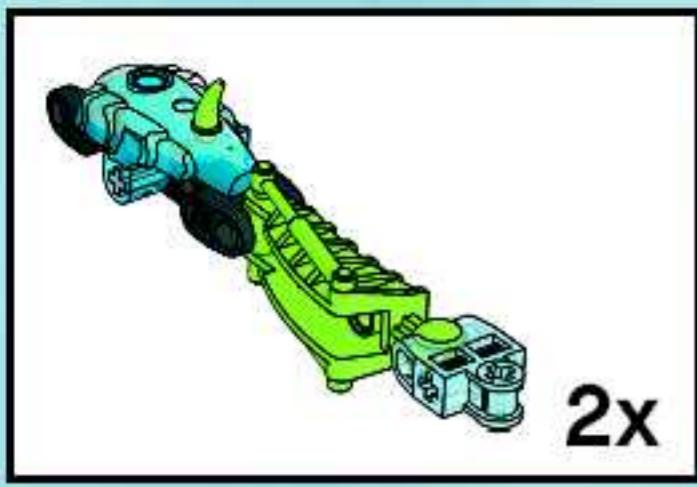

1

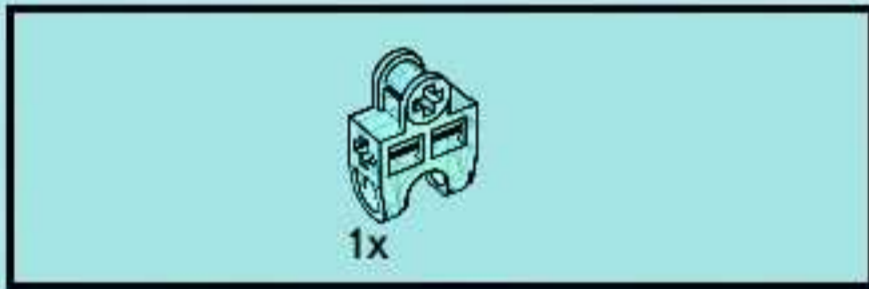
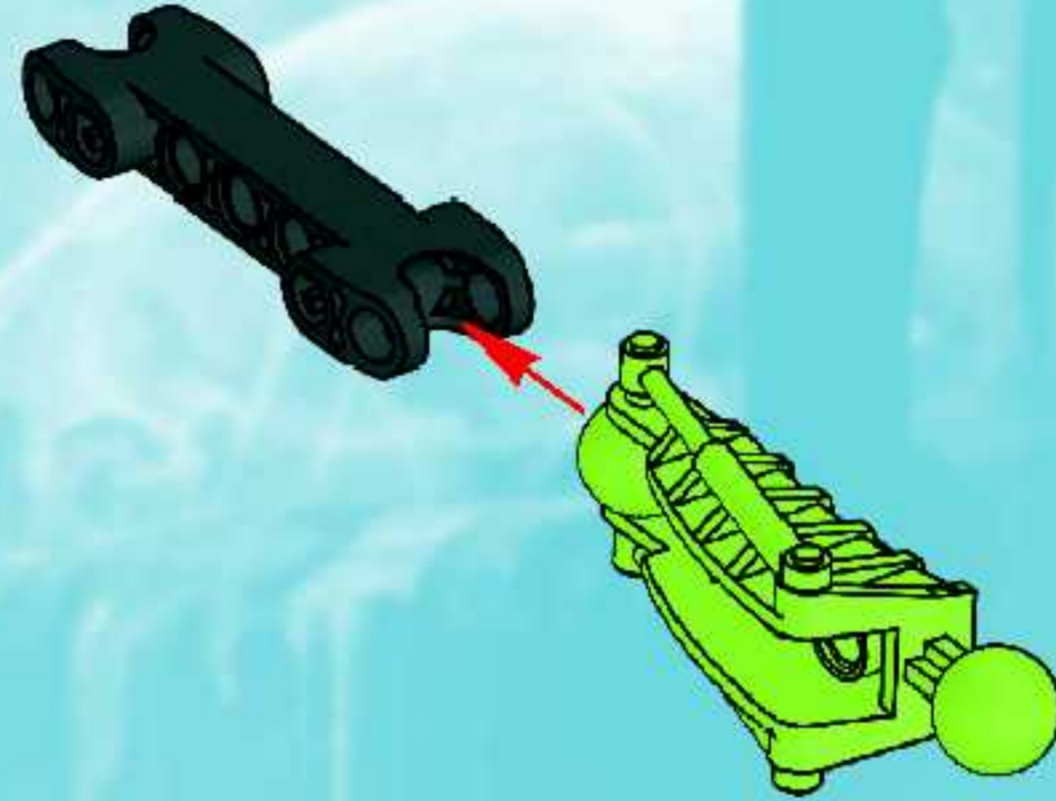

2

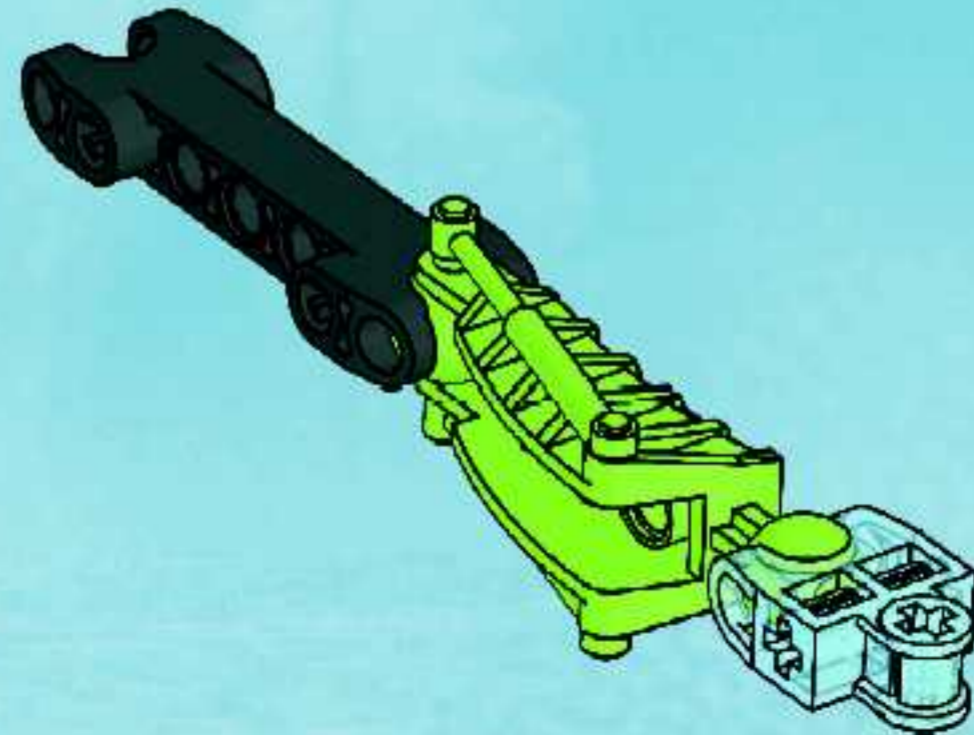

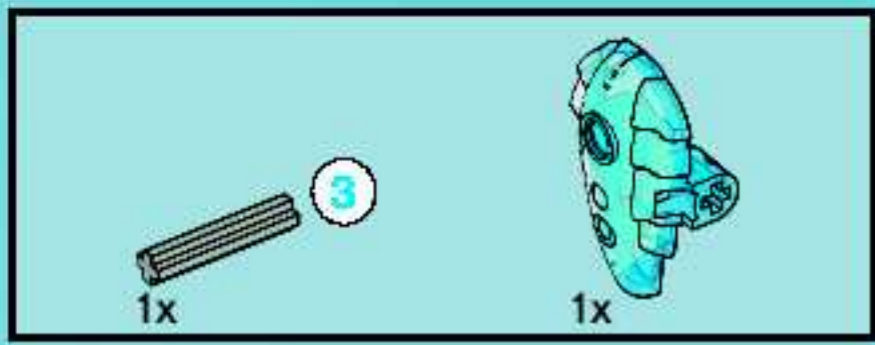

3

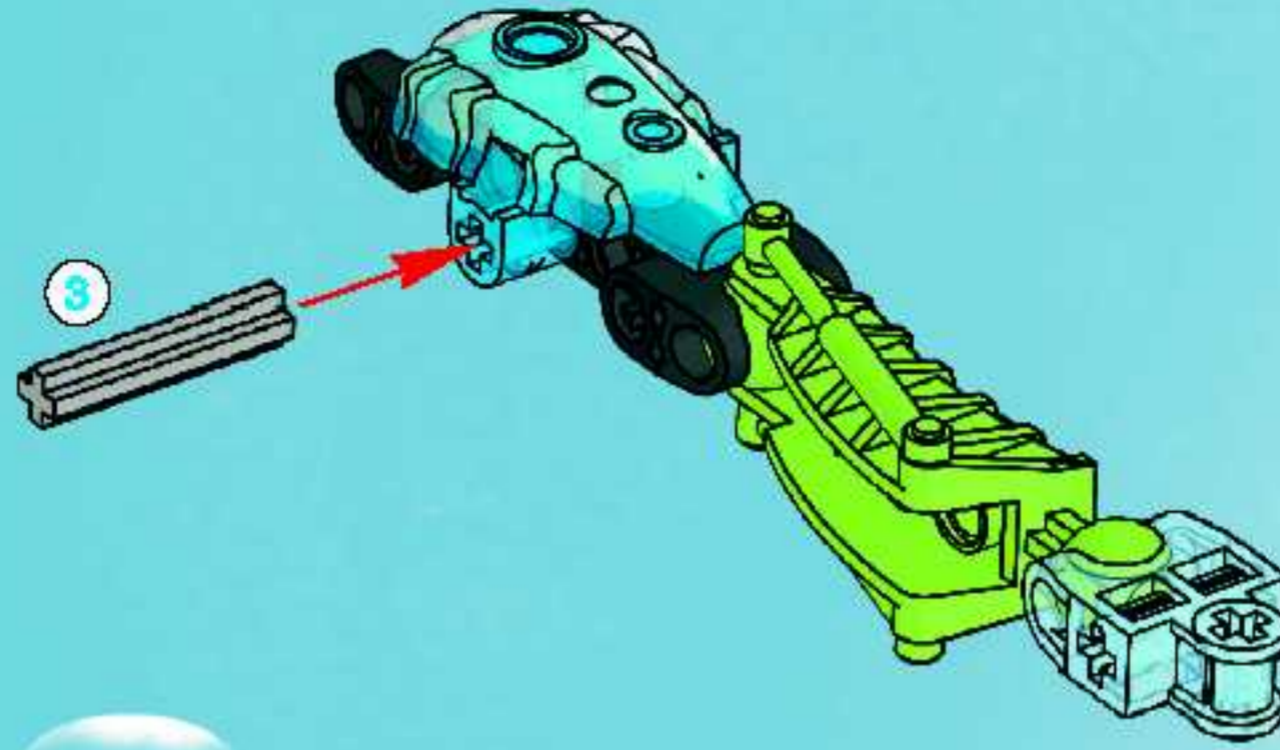

4

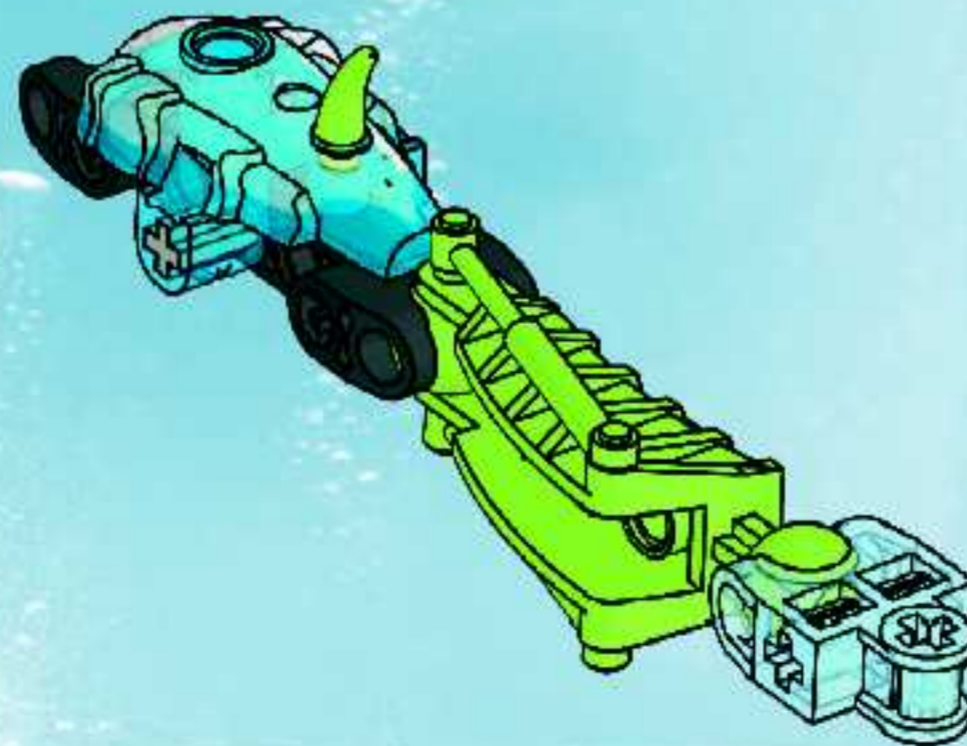

2x



8

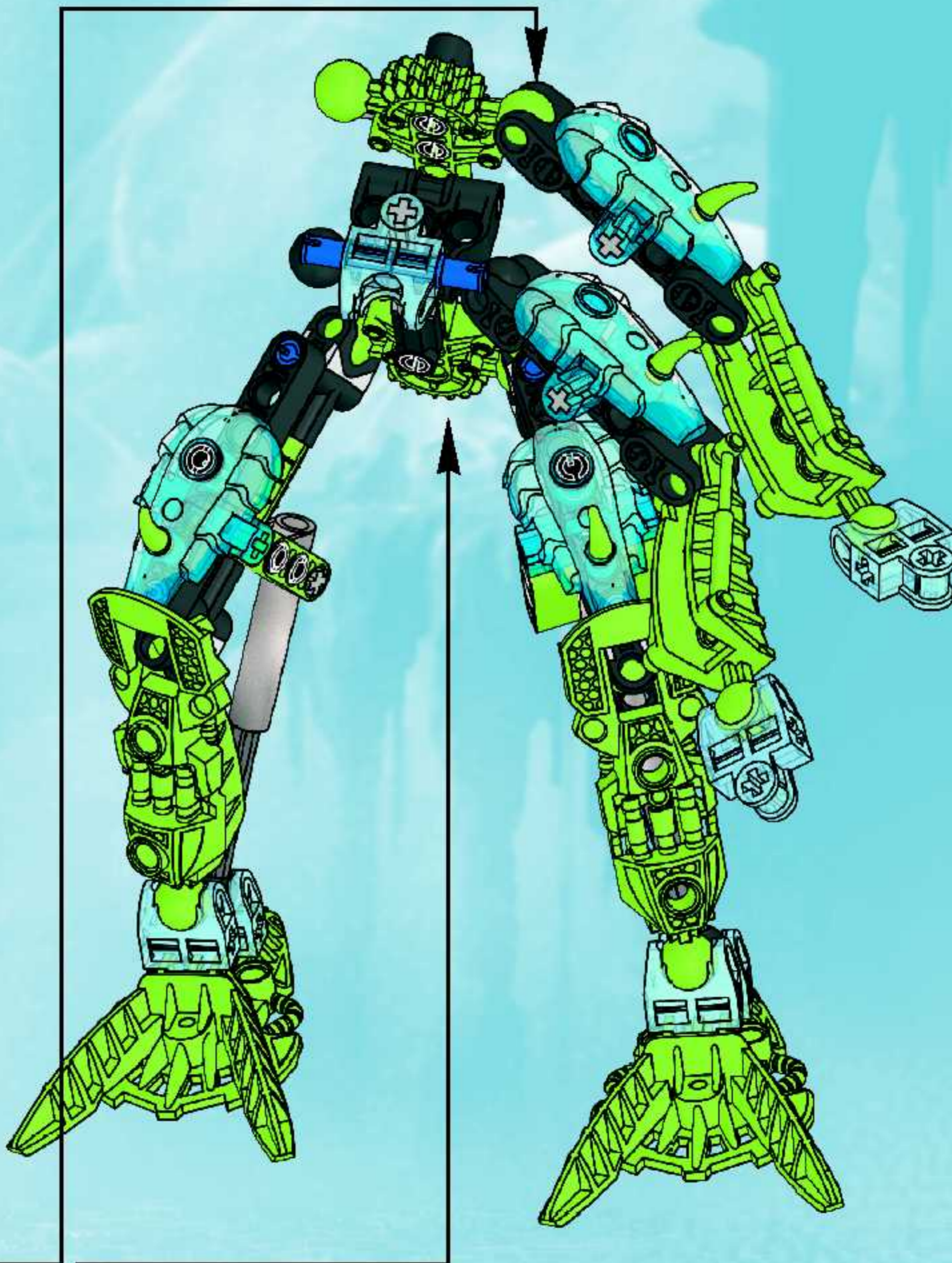

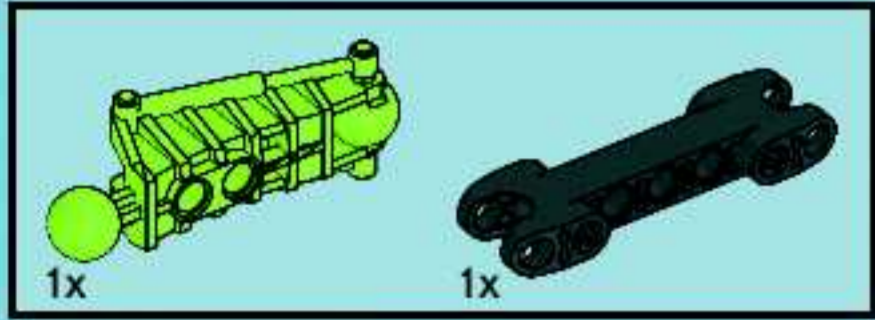
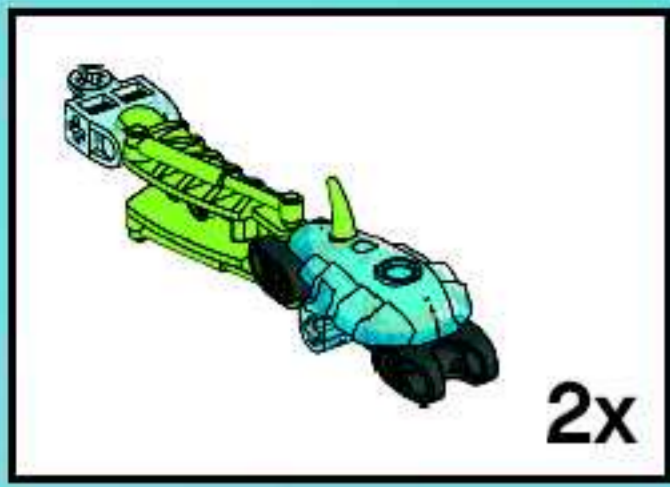

1

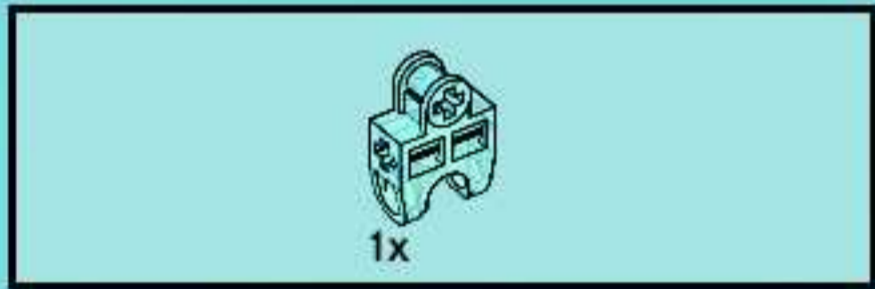
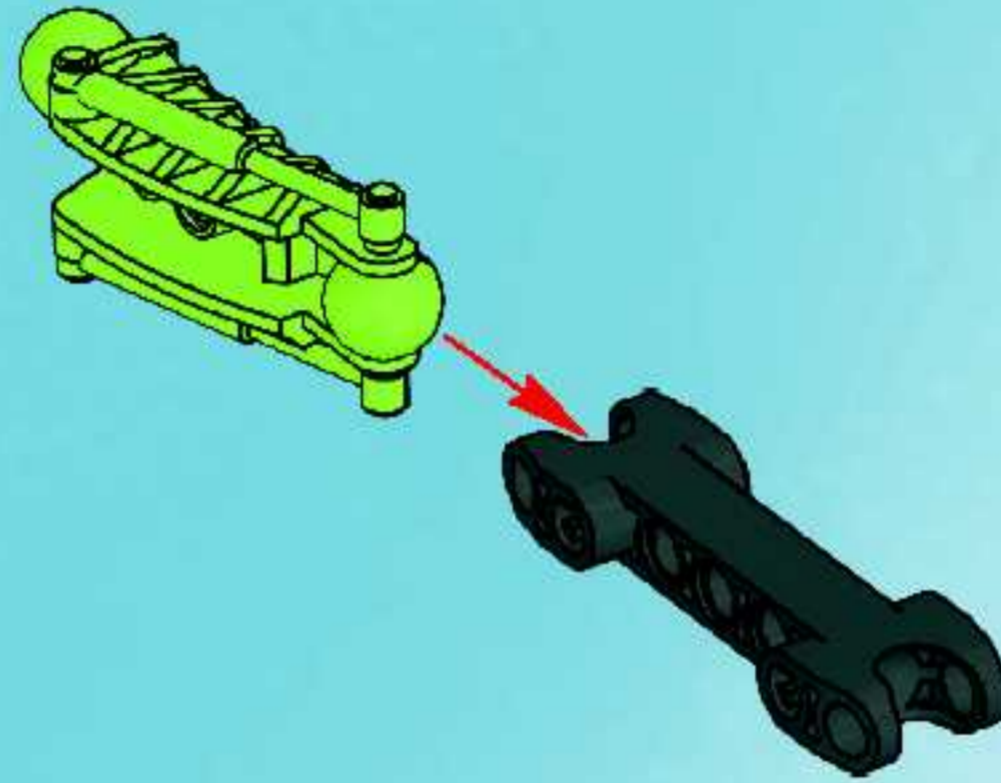

2

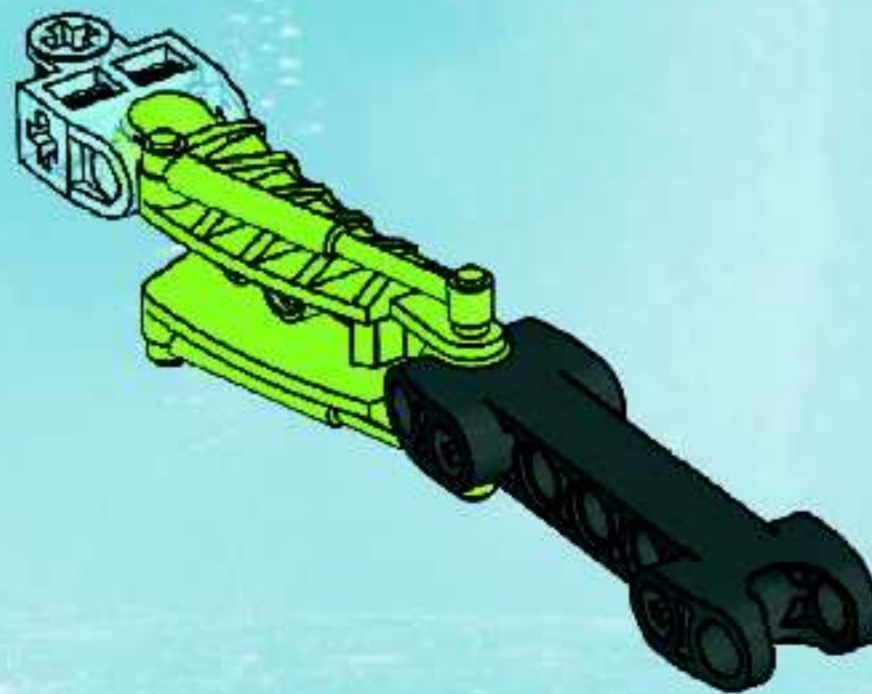

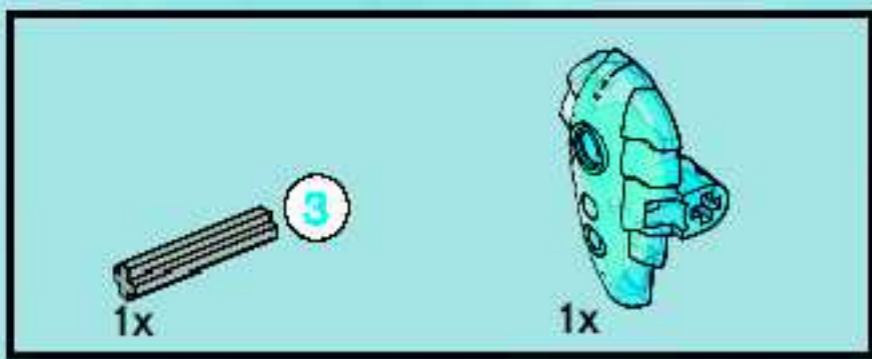

3

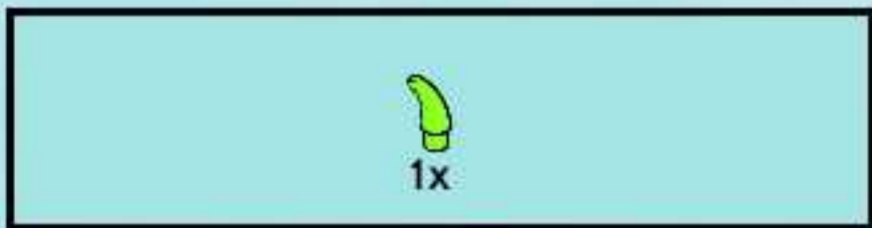
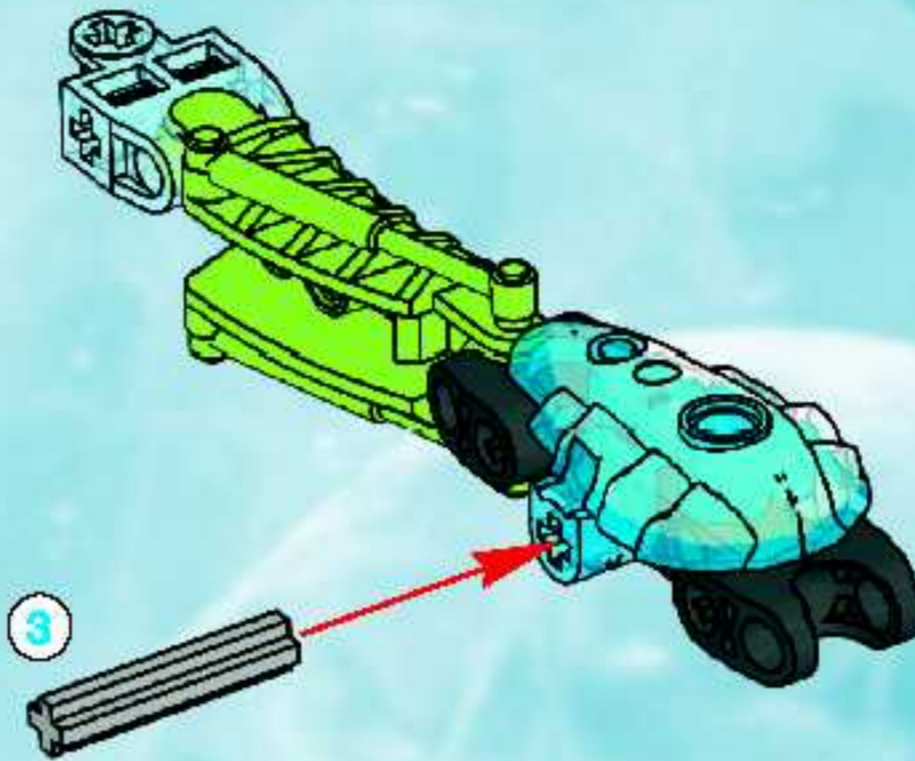

4

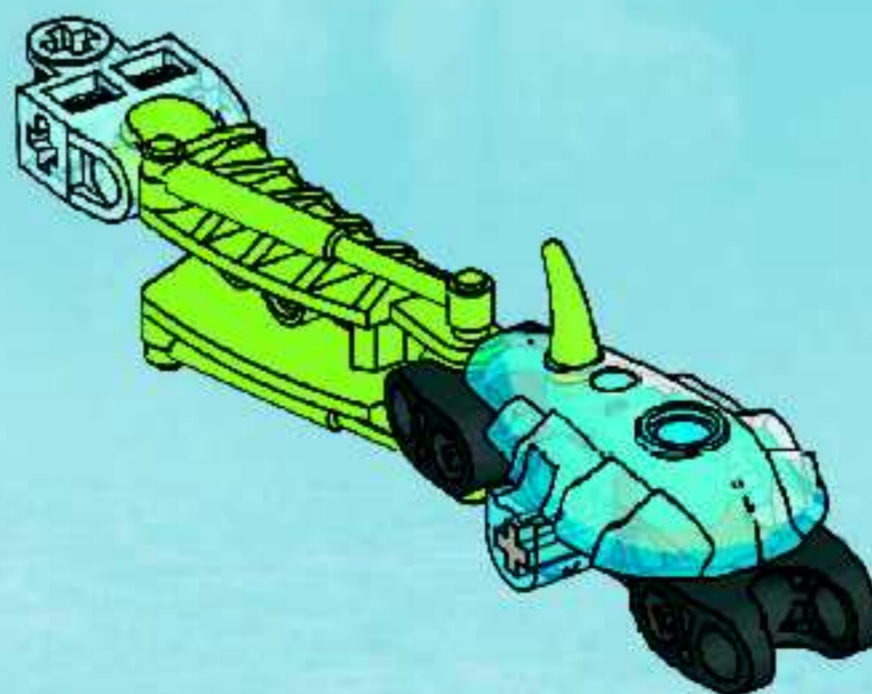

2x

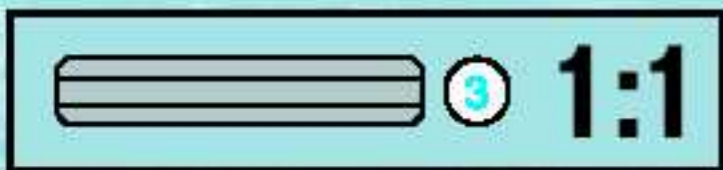

9

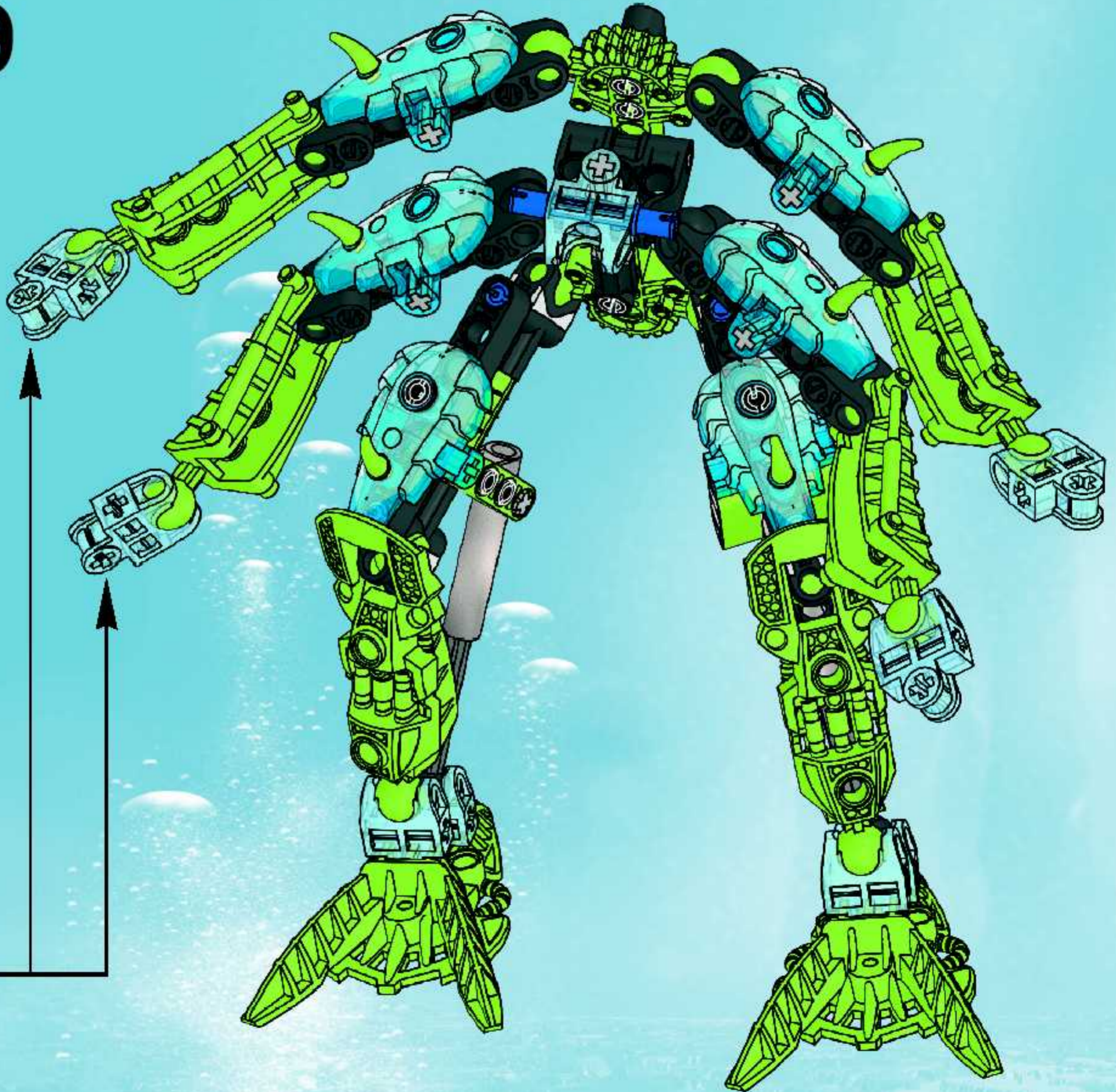

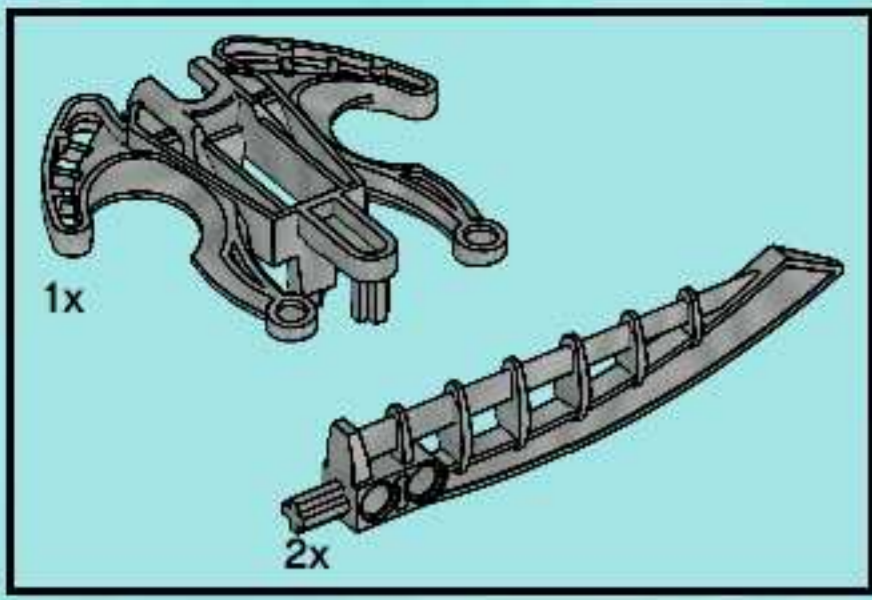

10

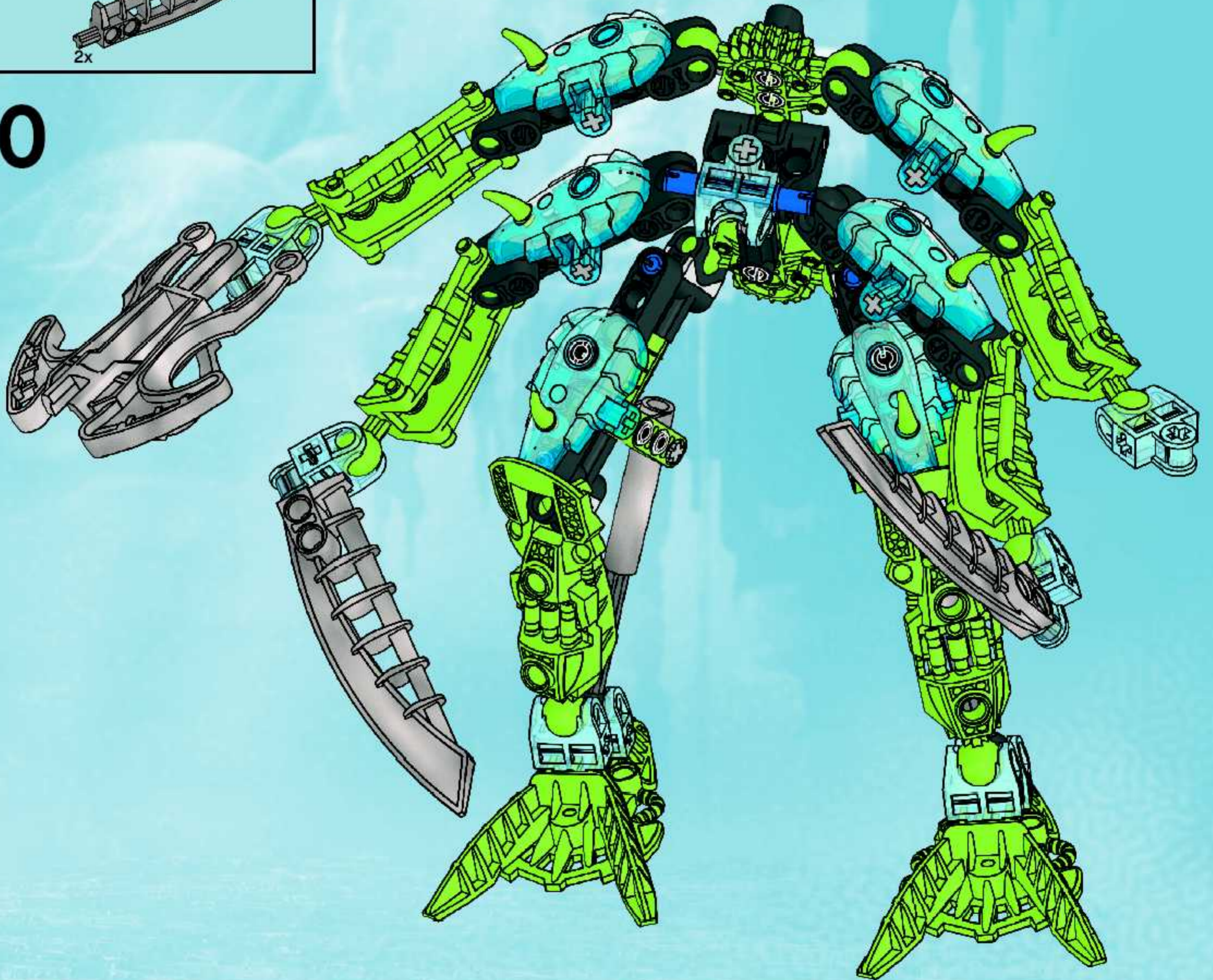

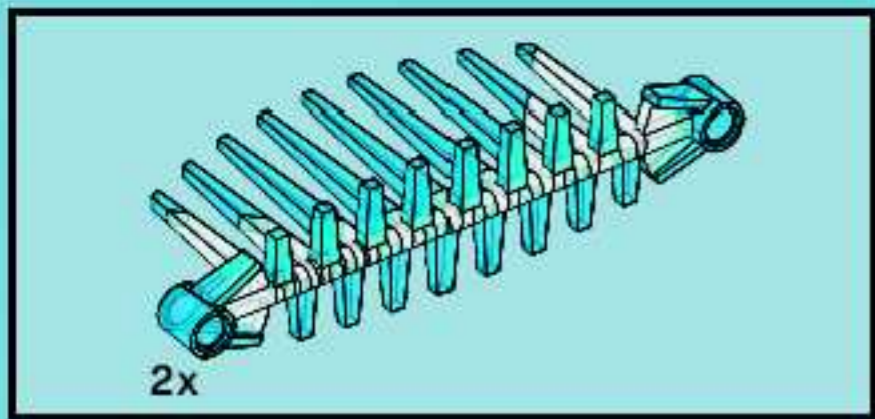

11

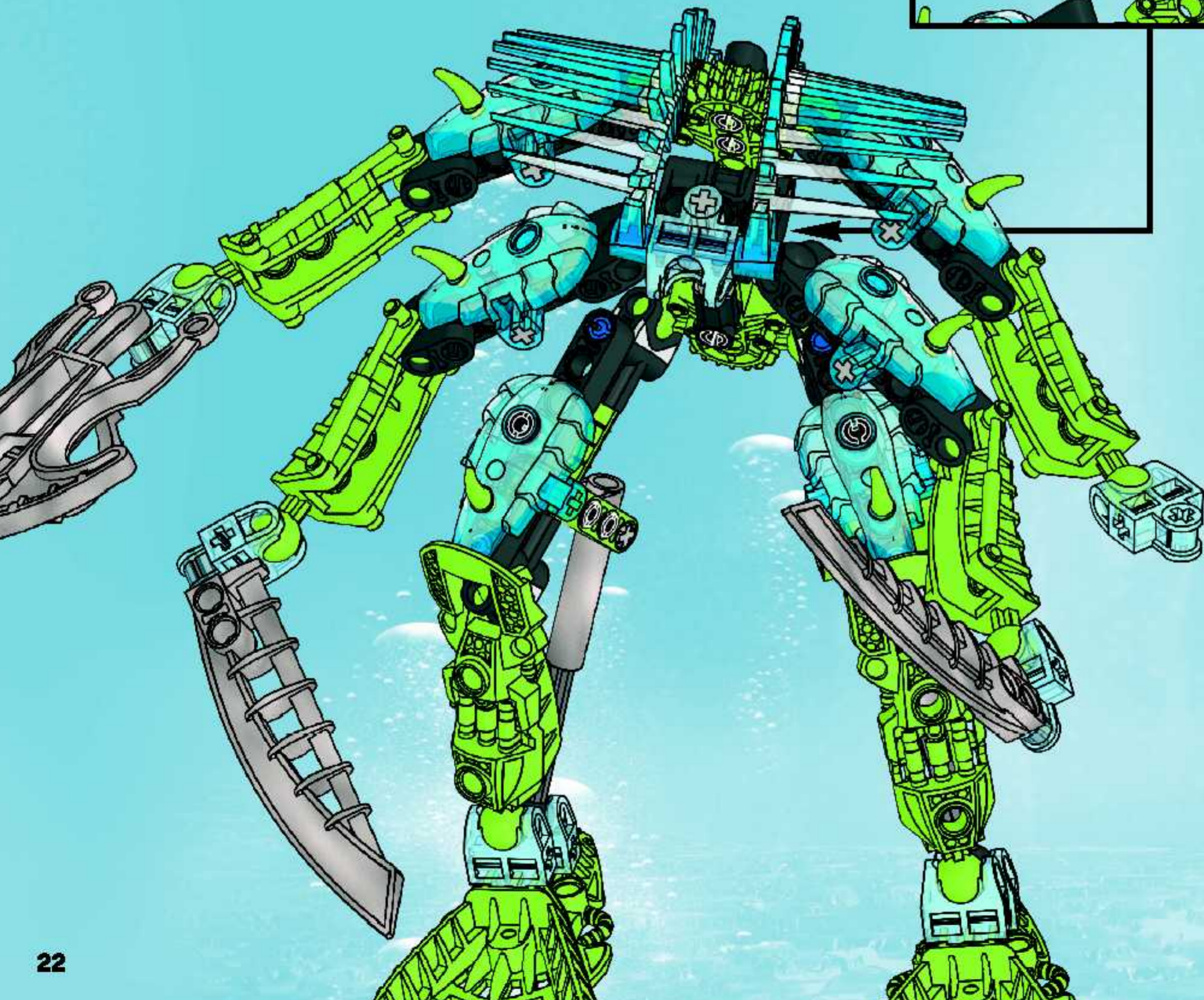
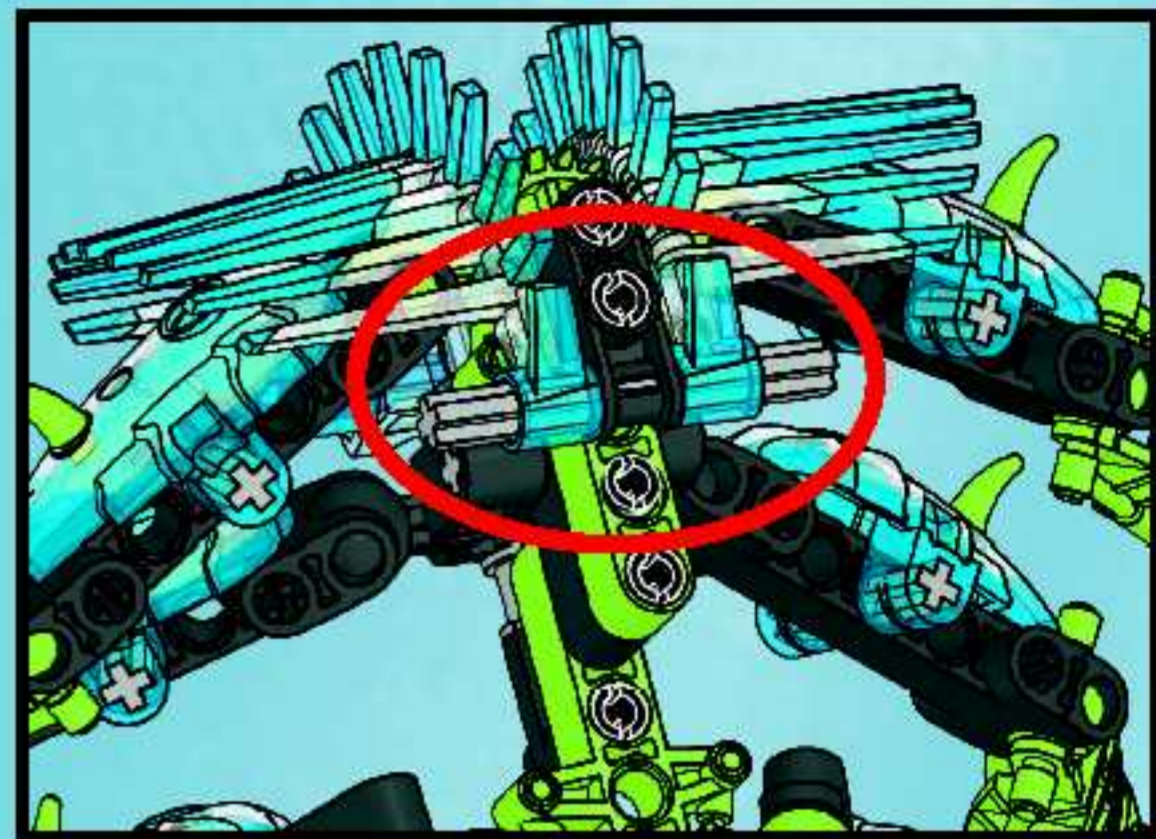



12

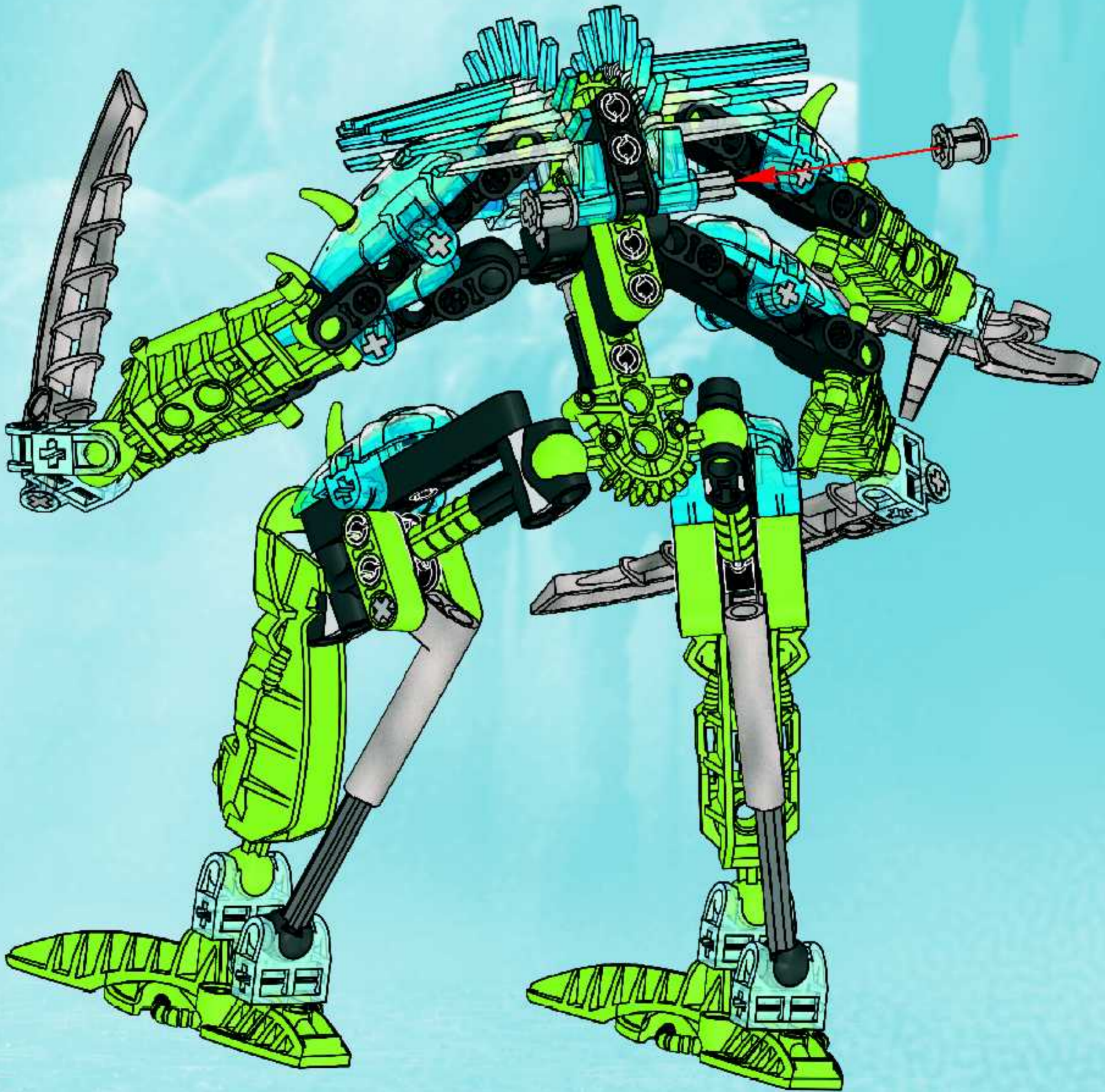

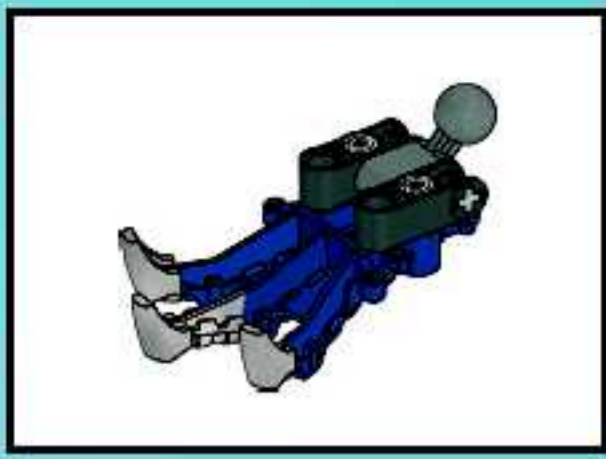

1



2

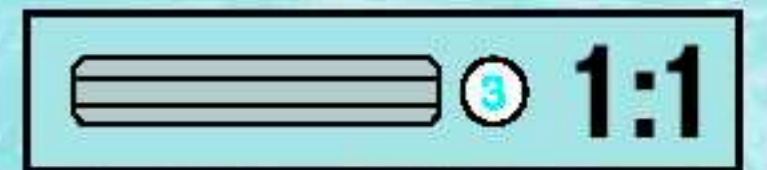
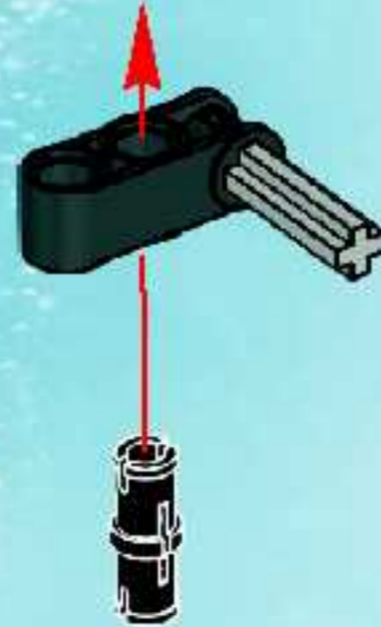

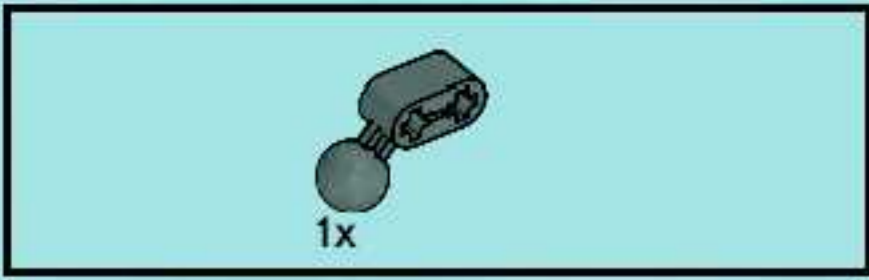

3

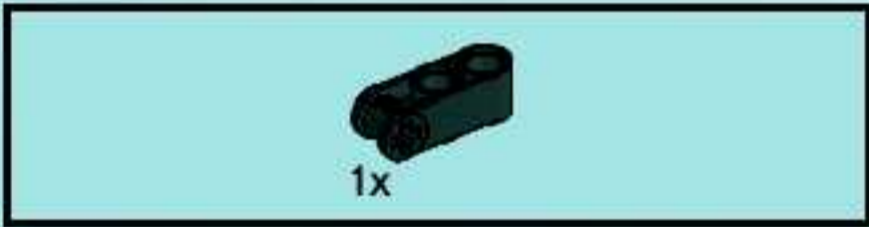

4





5

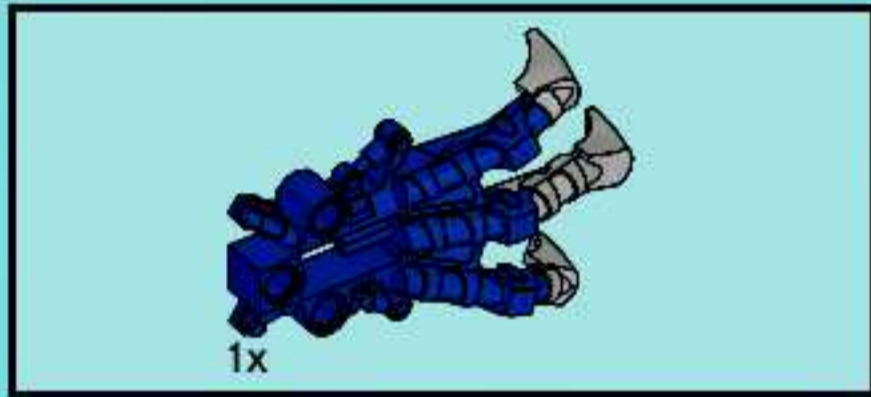

6

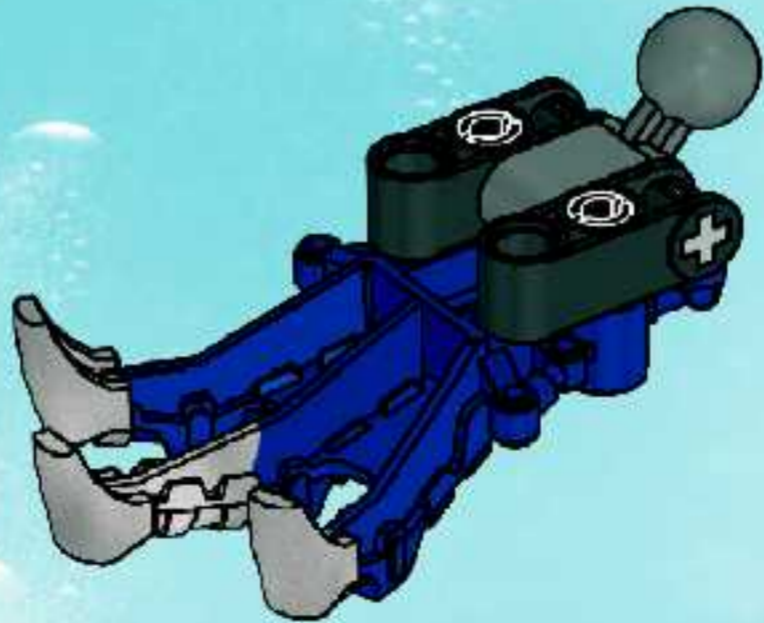

13

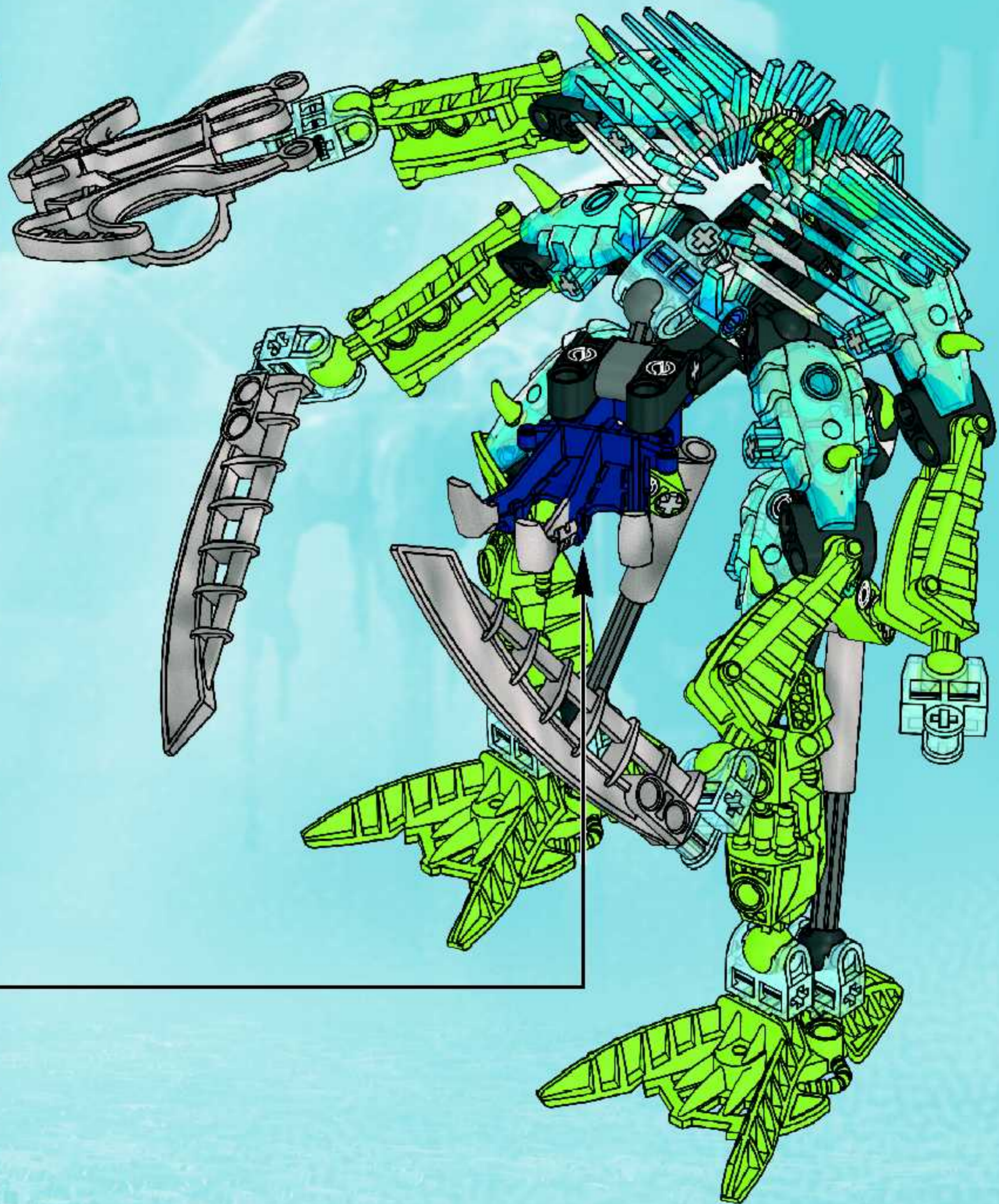

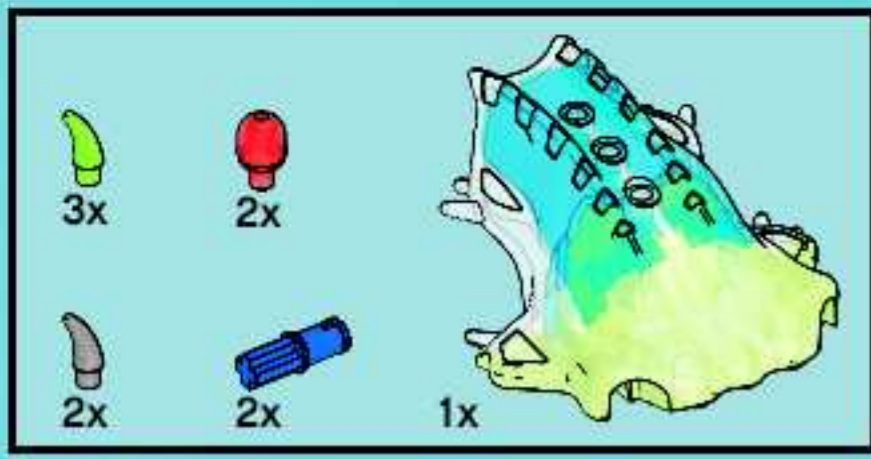

14

1



2

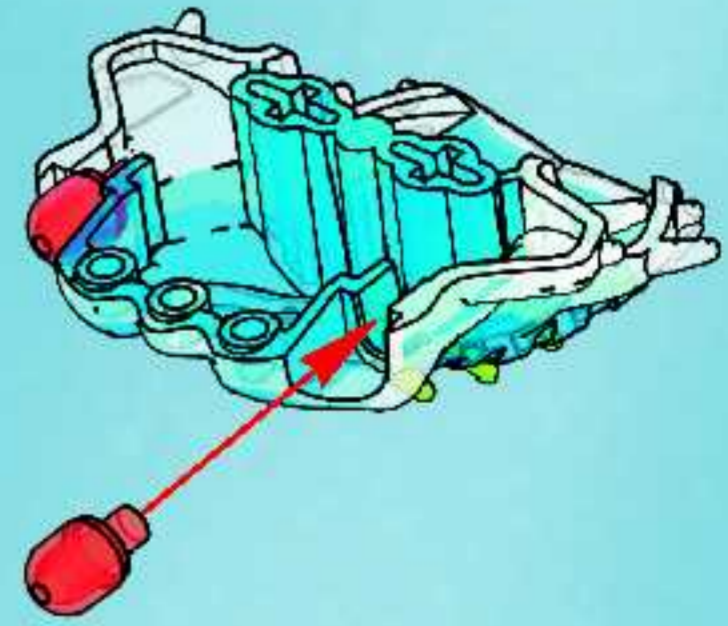

3

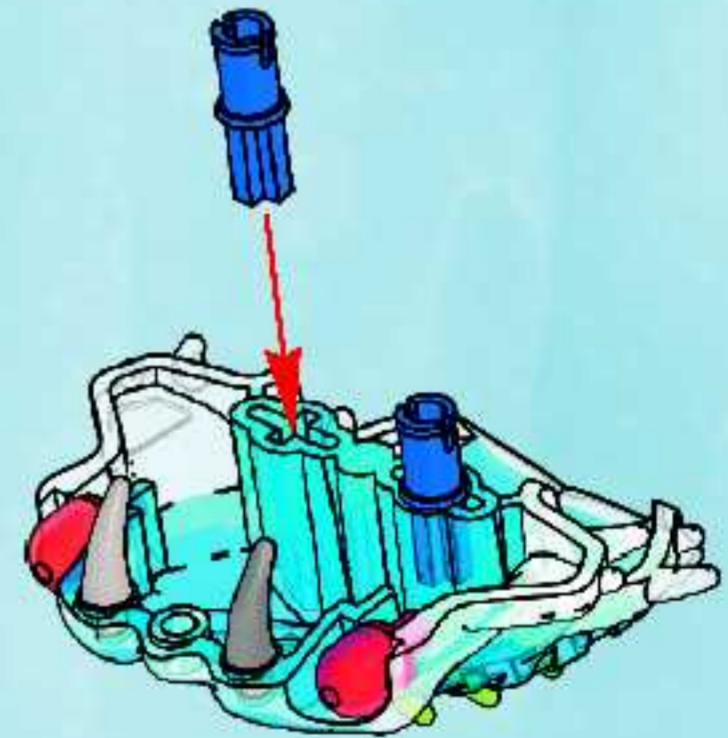

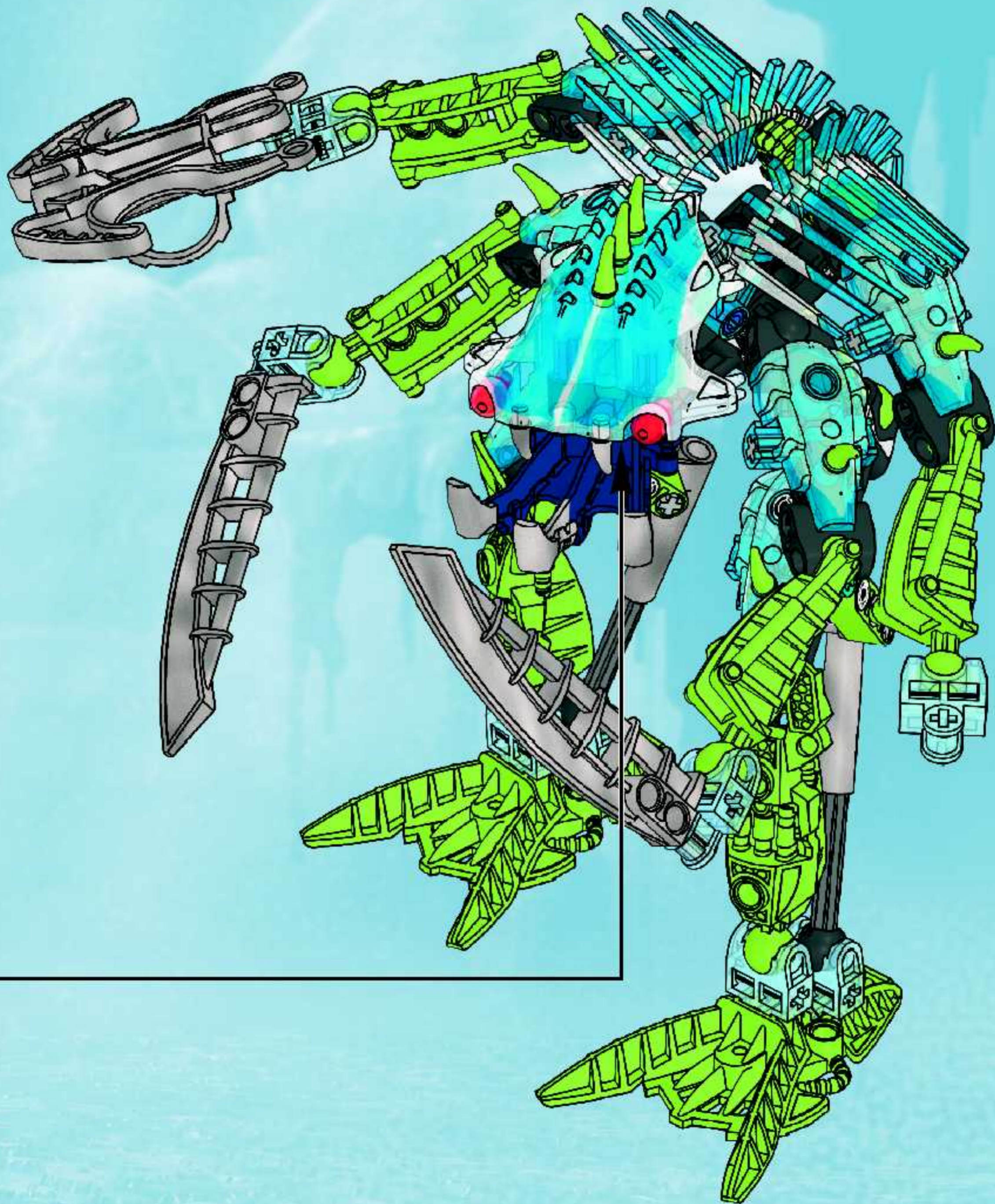

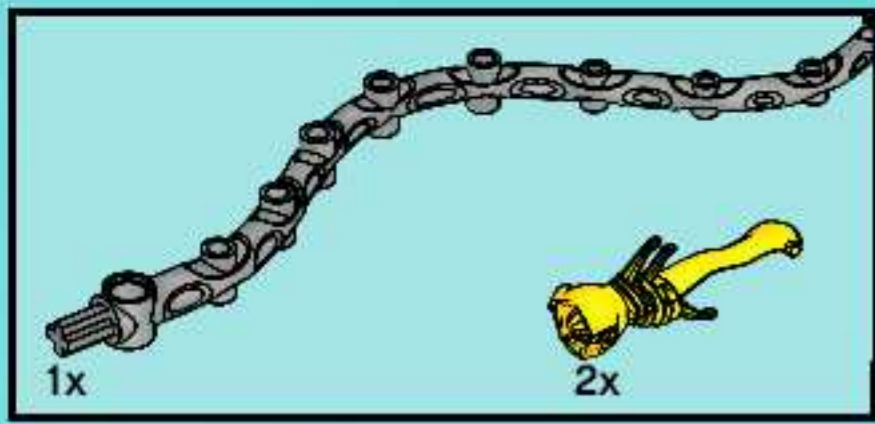

15

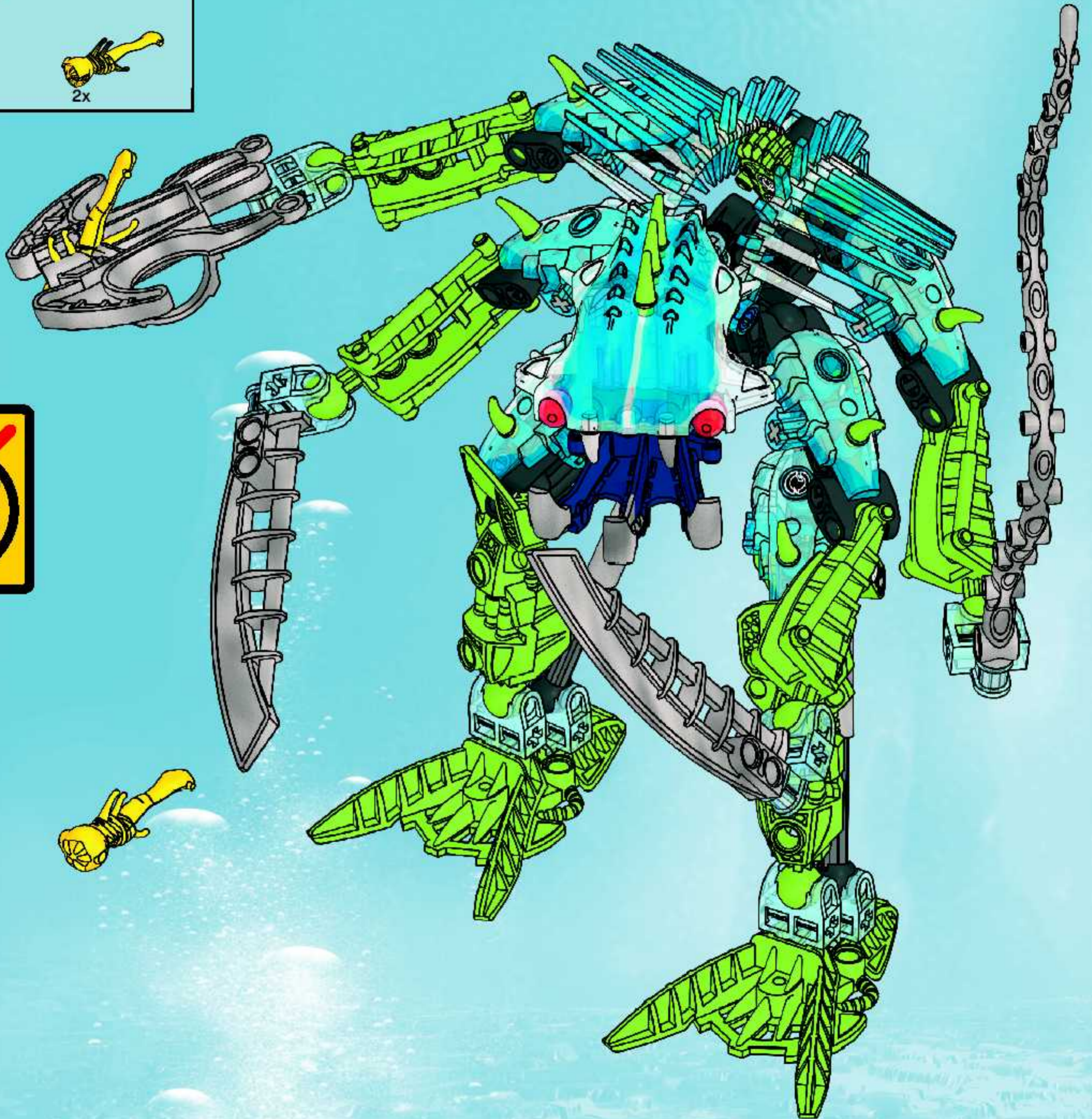

1



2



3



4





2x
4142865



2x
4497943



8x
4206482



6x
4499696



9x
4294865

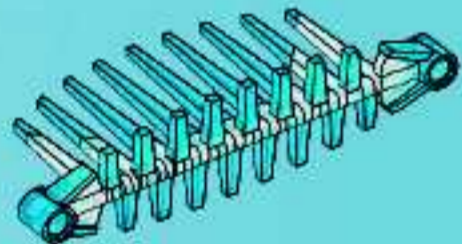

2x
4503165



7x
4121715



2x
655826



2x
4119589



1x
4107085



2x
4286267



4x
4235786



4x
4173970



2x
4495935



4x
4252528



1x
4289927



2x
4289538



4x
4211622



10x
4211815



2x
4211639



9x
4500378



2x
4265703



4x
4265684



2x
4503161



4x
4503162

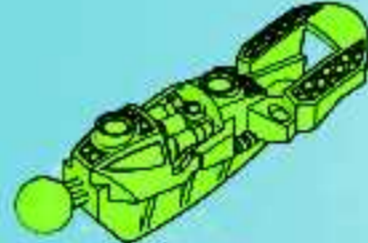

2x
4292536



2x
4503163



1x
4503164



1x
4289258



2x
4499858



1x
4287943



2x
4494086



2x
4494486

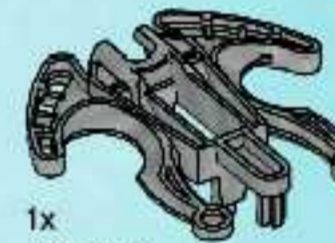

1x
4497131



2x
4178843



1x
4497139



2x
4511873

BIONICLE



BARRAKI

8917
KALMAH



8916
TAKADOX



8918
CARAPAR



8921
PRIDAK



8920
EHLEK



8934
SQUID AMMO

8919
MANTAX





Join the **LEGO Club!**

FREE LEGO Magazines!

Komm zum LEGO Club!

GRATIS LEGO Magazines!



www.LEGOclub.com

Any questions regarding your new LEGO product, please contact:
Hebt u vragen over uw nieuwe LEGO product, neem dan contact op met:

Customer Service • Kundenservice • Service Consommateurs
• Servicio Al Consumidor • Klantenservice: www.LEGO.com/service or call



00800-5346-5555



1-800-422-5346



SHOP at HOME



Visit the World's Biggest LEGO Shop!

- Get exclusive sets you won't find anywhere else and all the latest ranges
- Choose from hundreds of perfect gift ideas
- Order a FREE catalogue now!



www.LEGOshop.com

SERVICE
www.LEGO.com



NINTENDO DS

GAME BOY ADVANCE

NINTENDO GAMECUBE

PlayStation 2

PC CD-ROM

7+

www.pcg1.fr/10

eldos



WWW.BIONICLE.COM

©2007 The LEGO Group. 4506459